



Admin and Installation Guide  
v1.03

**Snom M900 and M900 Outdoor  
Base station**

## TABLE OF CONTENTS

<b>Copyright, Trademarks, Legal Disclaimers</b> .....	<b>4</b>
<b>Important information</b> .....	<b>5</b>
Suitable and unsuitable locations .....	5
Intended use .....	5
Safety precautions .....	5
Cleaning .....	7
Disposal .....	8
Standards conformance .....	8
Technical specifications .....	8
Additional important information USA .....	9
Regulatory information Canada .....	13
<b>Introduction</b> .....	<b>14</b>
<b>Setting up</b> .....	<b>15</b>
Power sourcing .....	15
M900 hardware setup .....	15
Wall mounting .....	16
User interface of the unit .....	17
LED status indicator .....	17
Reset key .....	17
<b>Configuring</b> .....	<b>19</b>
Preliminary steps .....	19
Finding the IP address of the base station .....	19
Opening the web user interface .....	20
Servers .....	21
Language, country, and time/date .....	21
Extensions .....	22
Setting up extensions .....	22
Registering handsets - method 1 .....	23
Registering handsets - method 2 .....	25
Selecting emergency alarm setting .....	26
Deregistering/deleting handsets and/or SIP registrations .....	27
Registering M5 repeaters .....	27
Automatic registration .....	27
Manual registration .....	29
Emergency alarm .....	31
<b>Central phone directory</b> .....	<b>32</b>
Local central directory .....	32
Preparing the phone directory file .....	32
Downloading the phone directory file onto base station .....	34

Polling from external directory server .....	35
LDAP .....	36
<b>Firmware update .....</b>	<b>37</b>
<b>Considerations before updating .....</b>	<b>37</b>
<b>Updating manually .....</b>	<b>37</b>
Using Snom's update server .....	38
Using your own server .....	38
Downloading update files to your server .....	38
Downloading update files to base station and transmitting to wireless devices .....	39
Updating the base station .....	40
Updating registered handsets .....	40
Provisioning updates .....	40
<b>Description of settings .....</b>	<b>41</b>
Home/Status .....	41
Extensions .....	43
Extensions page settings .....	43
Add/edit extension settings .....	44
Handset settings .....	46
Servers .....	48
Network .....	52
Management .....	55
Firmware update .....	58
Country/time settings .....	59
Country/region, language, and automatic time and DST settings .....	59
Time server .....	60
Manual time and DST settings .....	61
Security .....	62
Device identity .....	63
Central directory .....	65
Multicell .....	67
Repeaters .....	72
Alarm .....	73
Statistics .....	74
Call quality page .....	76
Configuration .....	77
Syslog .....	77
SIP Log .....	77
<b>Appendix 1 - Installing the M900 Outdoor .....</b>	<b>78</b>

# Copyright, Trademarks, Legal Disclaimers

© 2020 Snom Technology GmbH. All Rights Reserved.

Snom, the names of Snom products, and Snom logos are trademarks owned by Snom Technology GmbH. All other product names and names of enterprises are the property of their respective owners.

Product specifications are subject to change without notice.

Snom Technology GmbH reserves the right to revise and change this document at any time, without being obliged to announce such revisions or changes beforehand or after the fact.

Texts, images, and illustrations and their arrangement in this document are subject to the protection of copyrights and other legal rights worldwide. Their use, reproduction, and transmittal to third parties without express written permission may result in legal proceedings in the criminal courts as well as civil courts.

When this document is made available on Snom's web page, Snom Tech

nology GmbH gives its permission to download and print copies of its content for the intended purpose of using it as a manual. No parts of this document may be altered, modified or used for commercial purposes without the express written consent of Snom Technology GmbH.

Although due care has been taken in the compilation and presentation of the information in this document, the data upon which it is based may have changed in the meantime. Snom therefore disclaims all warranties and liability for the accurateness, completeness, and currentness of the information published, except in the case of intention or gross negligence on the part of Snom or where liability arises due to binding legal provisions.

# Important information

## Suitable and unsuitable locations

Please read the precautions and instructions on how to install the product thoroughly.

- The product is for indoor installation only. Not for outdoor installation!
- The operational temperature for the product is between -10°C and + 50°C (14°F and 122°F).
- The maximum humidity for the product is 70% noncondensing. Do not install product in rooms with high humidity (for example, in bathrooms, laundry rooms, damp basements).
- Do not install the product in locations where it may get splashed with water or chemicals.
- Do not install the product in surroundings at risk for explosions and do not use the product in such surroundings (paint shops, for example).
- Do not install the product near air conditioners or air conditioning vents, radiators, in very dusty surroundings, or where it is exposed to direct sunlight.
- Avoid placing the device's Ethernet cable where people may trip over it. Avoid placing the cable where it may be exposed to mechanical pressure as this may damage it. If the cable is damaged, disconnect the device and contact qualified service personnel.
- Proximity to metal surfaces , electric current lines, and water pipes might degrade signal reception/transmission. We recommend to not install the product directly on metal surfaces and to maintain a minimum distance of 20 cm (8 Inches) from electric current lines and water pipes.
- Medical devices might be adversely affected. Please consider the technical ramifications when installing the device in a doctor's office, for example.
- Install the product at a minimum distance of 100 cm (39") to persons and animals.

## Intended use

This product is designed for use with a Snom M-series telephone. Any other use is considered unintended use. Any modification or reconstruction not described in the user manual is considered unintended use.

## Safety precautions

Please read these precautions and the instructions on how to set up and use the device thoroughly before using it. Save this info sheet and do not give the device to third parties without it. Please also note the information on the proper disposal of the device.

- Avoid placing the device's Ethernet cable (and power cord, if applicable) where people may trip over them. Avoid placing the cables where they may be exposed to mechanical pressure as this may damage them. If the PoE cable or the power cord is damaged, disconnect the device and contact qualified service personnel.
- The product is for indoor installation only. Not for outdoor installation!

- The operational temperature for the product is between -10°C and + 50°C (14°F and 122°F).
- Do not install product in rooms with high humidity (for example, in bathrooms, laundry rooms, damp basements). Do not immerse product in water and do not spill or pour liquids of any kind onto or into any parts of it.
- Do not install product in surroundings at risk for explosions and do not use the product in such surroundings (paint shops, for example). Do not use the product if you smell gas or other potentially explosive fumes!
- Install the product at a minimum distance of 100 cm (39") to persons and animals.
- Medical devices might be adversely affected. Please consider the technical ramifications when installing the device in a doctor's office, for example.
- FOR THE USA: Do not use near medical equipment or if you have a pacemaker.

#### **If you have an implanted pacemaker**

- Do not use if you have an implanted pacemaker unless the pacemaker manufacturer's directions expressly permit the use of devices emitting pulsating radio frequency signals. Always follow the manufacturer's directions!
- Recommended MINIMUM distance to the device: 100 cm (39").
- Turn the device off immediately if there is any reason to suspect that interference is taking place.
- FOR THE USA: Do not use if you have a pacemaker.

## **Additional safety information**

### **Small children**

Your device and its enhancements may contain small parts. Keep them out of the reach of small children.

### **Operating environment**

Remember to follow any special regulations in force in any area, and always switch off your device when its use is prohibited or when it may cause interference or danger. Use the device only in its normal operating positions. Do not place credit cards or other magnetic storage media near the device, because information stored on them may be erased.

### **Medical devices**

Operation of any equipment emitting radio frequency signals may interfere with the functionality of inadequately shielded medical devices. Consult a physician or the manufacturer of the medical device to determine if they are adequately shielded from external radio frequency (RF) energy or if you have any other questions concerning this topic. Switch off your device in health care facilities when signs posted in these areas instruct you to do so. Hospitals or health care facilities may be using equipment that could be sensitive to external RF energy.

## Implanted medical devices

Manufacturers of medical devices recommend that a minimum distance should be maintained between a wireless device and an implanted medical device, such as pacemakers or cardioverter defibrillators, to avoid potential interference with the medical device. Persons who have such devices should:

- Always keep the wireless device more than 100 centimeters (39 inches) from the medical device when the wireless device is turned on.
- Not carry the wireless device in a breast pocket.
- Hold the wireless device to the ear opposite the medical device to minimize the potential for interference.
- Turn the wireless device off immediately if there is any reason to suspect that interference is taking place.
- Read and follow the directions of the medical device's manufacturer.
- If you have any questions about using your wireless device with an implanted medical device, consult your health care provider.

## SELV (Safety Extra Low Voltage) Compliance

Safety status of Input/Output connections comply with SELV requirements.

## Potentially explosive environments

Switch off your device when in any area with a potentially explosive atmosphere and obey all signs and instructions. Sparks in such areas could cause an explosion or fire resulting in bodily injury or even death. Switch off the device at refuelling points such as near gas pumps at service stations. Observe restrictions on the use of radio equipment in fuel depots, storage, and distribution areas; chemical plants; or where blasting operations are in progress. Areas with a potentially explosive atmosphere are often but not always clearly marked. They include below deck on boats, chemical transfer or storage facilities, vehicles using liquefied petroleum gas, and areas where the air contains chemicals or particles such as grain dust or metal powders.

## Sensitive electronic equipment

The current state of research concludes that operational DECT phones normally do not adversely affect electronic equipment. Nevertheless, you should take some precautions if you want to operate DECT phones in the immediate vicinity of such equipment like sensitive laboratory equipment. Always keep a minimum distance of 10 cm (3.94") to the equipment even when the phone is in standby.

## Electrical surges

We recommend the installment of an AC surge arrester in the AC outlet to which this device is connected to avoid damage to the equipment caused by local strikes of lightning or other electrical surges.

## Cleaning

Use an anti-static cloth. Please avoid water and liquid or solid cleaning products as they might damage the surface or internal electronics of the base, charger, and handset.

## Disposal



This product is subject to European Directive 2012/19/EU and may not be disposed of with general household garbage.

If you do not know where you may dispose of the device at the end of its lifespan, contact your municipality, your local waste management provider, or your seller.

## For countries outside the European Union

Disposal of electrical and electronic products in countries outside the European Union should be done in line with local regulations. Please contact local authorities for further information.

## Standards conformance



This device complies with the essential health, safety, and environmental requirements of all relevant European directives. This device is FCC and IC certified and meets US and Canadian health, safety, and environmental standards.

Unauthorized opening, changing, or modifying the device will cause the warranty to lapse and may also result in the loss of CE conformity and the FCC and IC certifications. In case of malfunction contact authorized service personnel, your seller, or Snom.

The declaration of conformity can be downloaded at [www.snom.com/conformity](http://www.snom.com/conformity).

## Technical specifications

### M900

- **Safety:** IEC 62368-1
- **Connectors**
  - **PoE:** RJ45 (8P8C)
  - **Power jack:** DC 5VDC@2A (if PoE is not available)
- **Power.**
  - **Power over Ethernet (PoE):** IEEE 802.3, Class 2, 10/100 Base-T interface. If PoE is not available, the power adapter can be ordered separately:
  - **Power adapter** (not included in delivery): Ten Pao SMPS power adapter, 5VDC 2A, model no. S018BAM0500200
    - EU: Snom article no. 00004439
    - US: Snom article no. 00004440

### M900 Outdoor

- **Safety:** IEC 62368-1
- **Connector:** PoE, RJ45 (8P8C)
- **Power:** Power over Ethernet (PoE). IEEE 802.3, Class 2, 10/100 Base-T interface.



## Additional important information USA

FCC ID: T7HX8663

### Intended use

This device is designed for use with Snom M-series phones. Any other use, modification or reconstruction of the product is considered unintended use.

### Important safety information

Follow all instructions and warnings in the user manual, and on the equipment to prevent accidents.

### WARNING

Fire, electric shock, or other injury may result if you do not observe the following safety precautions:

- Do not use in or near a bathtub, sink, swimming pool, wet basement, or other water.
- Do not use this or any cordless telephone in the vicinity of a gas leak.
- Do not use in environments subject to explosion hazards, such as auto paint shops.
- Do not use near medical equipment or if you have a pacemaker.
- Unplug from wall outlet before cleaning.
- To prevent overheating, do not block slots and openings in the cabinet or the back or bottom of equipment. Do not place equipment on beds, sofas, rugs, or other surfaces that generate fibers.
- To prevent overheating, do not place near or over a radiator or in a cabinet without proper ventilation.
- To reduce the risk of fire, use only 26 AWG or larger UL-listed or CSA-certified telecommunication line cord.
- Operate using the power source indicated on the marking label. If you are unsure about the type of power supply to your home or business, consult your power company.
- Do not place objects on the power cord. Do not step on the power cord.
- To prevent exposure to dangerous voltage, do not push objects through cabinet slots.
- To reduce the risk of electric shock, do not disassemble equipment or open parts other than specified access doors. Opening or removing parts may expose you to dangerous voltage or other risks. Incorrect reassembly can cause electric shock when equipment is subsequently used.
- Do not overload wall outlets and extension cords.
- Unplug equipment and contact qualified service if any of the following has occurred:
  - Power supply cord or plug has been damaged or frayed.
  - Liquid has been spilled on or in the equipment.
  - Equipment has been exposed to rain or water.
  - Equipment does not work normally even when the operating instructions are followed. Adjust only those controls referred to in the operating instructions. Improper adjustment of other controls may result in damage and may require extensive work by an authorized service center.

- Equipment has been dropped and damaged.
- Equipment has exhibited a distinct change in performance.
- Do not put the handset of the telephone next to your ear when the handset is not in normal talk mode.
- Radio signals transmitted between the handset and base may cause interference with hearing aids.
- The cord may contain lead, a chemical known to the State of California to cause birth defects or other reproductive harm. Wash hands after handling.
- Install the product at a minimum distance of 100 cm (39") to persons and animals.

### **Installation guidelines**

Follow all warnings and instructions.

- Do not install equipment near a bath tub, sink, or shower.
- Operate the equipment using only the power source indicated on the marking label. If you are unsure of the power supply to your home or business, consult with your power company.
- To avoid interference to nearby appliances, do not place base of the phone on or near a television, VCR, or microwave oven.
- Do not expose the equipment to direct sunlight.
- Do not place equipment on an unstable cart, stand, or table.
- Adjust only those controls referred to in the operating instructions. Improper adjustment of other controls may result in damage and may require extensive work to restore equipment to normal operation.
- The location of the device should be close to a continuous power outlet (an AC outlet that does not have a switch to interrupt power).
- Keep the device away from sources of electrical noise such as motors or fluorescent lighting.

### **NOTICE**

To avoid damage to the equipment, observe the following precautions:

- Do not expose to water, rain, or moisture.
- Place securely on a stable surface.
- To avoid damage during an electrical storm, equipment should be plugged into a surge protector.

### **Cordless telephone privacy**

Cordless telephones are radio devices. Communications between the handset and base of your cordless telephone are accomplished by means of radio waves which are broadcast over the open airways. Because of the inherent physical properties of radio waves, your communications can be received by radio receiving devices other than your own cordless telephone unit. Consequently, any communications using your cordless telephone may not be private.

## Cleaning

Do not clean with liquid or aerosol cleaners, household polish, chemicals, or cleaning agents. To avoid static shock, do not clean with a dry cloth. Clean with only a damp (not wet) cloth.

## Disposal

Disposal of electrical and electronic products should be done in line with local regulations. Please contact local authorities for further information.

## FCC and other information

This equipment complies with Parts 68 of the FCC rules and the requirements adopted by the Administrative Council for Terminal Attachments (ACTA).

This device complies with part 15 of the FCC rules. Operation is subject to the following two conditions: (1) This device may not cause harmful interference, and (2) This device must accept any interference received, including interference that may cause undesired operation. Privacy of communications may not be ensured when using this phone.

These limits are designed to provide reasonable protection against harmful interference in a residential installation. This equipment generates, uses and can radiate radio frequency energy and, if not installed and used in accordance with the instructions, may cause harmful interference to radio communications. However, there is no guarantee that interference will not occur in a particular installation. If this equipment does cause harmful interference to radio or television reception, which can be determined by turning the equipment off and on, the user is encouraged to try and correct the interference by one or more of the following measures:

- Reorient or relocate the receiving antenna.
- Increase the separation between the equipment and receiver.
- Connect the equipment into an outlet or on a circuit different from that to which the receiver is connected.
- Consult the dealer or an experienced radio/TV technician for help.

## FCC RF exposure warning

To insure the safety of users, the FCC has established criteria for the amount of radio frequency energy various products may produce depending on their intended usage. This product has been tested and found to comply with the FCC's exposure criteria. For body worn operation, the FCC RF exposure guidelines were also met when used with the accessories supplied or designed for this product. Use of other accessories may not ensure compliance with FCC RF exposure guidelines and should be avoided.

**Caution:** To maintain compliance with the FCC's RF exposure guidelines, the internal antennas used for this mobile transmitter must provide a separation distance of at least 20 cm from all persons. The device must not be co-located or operating in conjunction with any other antenna or transmitter.

**Caution:** Any changes or modifications not expressly approved by the party responsible for compliance could void the user's authority to operate this device.

## Health and safety information FCC

### Exposure to radio frequency (RF) signals

This device is a radio transmitter and receiver. It is designed and manufactured not to exceed the emission limits for exposure to radio frequency (RF) energy set by the Federal Communications Commission of the U.S. Government. These limits are part of comprehensive guidelines and establish permitted levels of RF energy for the general population. The guidelines are based on the safety standards previously set by both U.S. and international standards bodies:

This product has been shown to be capable of compliance for localized specific absorption rate (SAR) for uncontrolled environment/general population exposure limits specified in ANSI/IEEE Std. C95.1-1992 and has been tested in accordance with the measurement procedures specified in FCC/OET Bulletin 65 Supplement C (2001) and IEEE Std. 1528-2003 (December 2003).

### Standards conformance

This device is FCC certified and meets US health, safety, and environmental standards. The declaration of conformity can be downloaded at [www.snom.com/conformity](http://www.snom.com/conformity).

FCC ID: T7HX8663

Unauthorized opening, changing, or modifying the device will cause the warranty to lapse and may also result in the loss of the FCC certification. In case of malfunction contact authorized service personnel, your seller, or Snom.

#### M900

- **Safety:** IEC 62368-1
- **Connectors**
  - **PoE:** RJ45 (8P8C)
  - **Power jack:** DC 5VDC@2A (power adapter not included in delivery)
- **Power.**
  - **Power over Ethernet (PoE):** IEEE 802.3, Class 2, 10/100 Base-T interface. If PoE is not available, the power adapter can be ordered separately:
  - **Power adapter:** (not included in delivery): Ten Pao SMPS power adapter, 5VDC 2A, model no. S018BAM0500200, Snom article no. 00004440 (US)

#### M900 Outdoor

- **Safety:** IEC 62368-1
- **Connector:** PoE, RJ45 (8P8C)
- **Power:** Power over Ethernet (PoE). IEEE 802.3, Class 2, 10/100 Base-T interface.

## Regulatory information Canada

**IC Number: 4979B-X8663**

### Interference information

This device complies with Industry Canada licence-exempt RSS standard(s). Operation is subject to the following two conditions: (1) this device may not cause interference, and (2) this device must accept any interference, including interference that may cause undesired operation of the device.

Le présent appareil est conforme aux CNR d'Industrie Canada applicables aux appareils radio exempts de licence. L'exploitation est autorisée aux deux conditions suivantes: (1) l'appareil ne doit pas produire de brouillage, et (2) l'utilisateur de l'appareil doit accepter tout brouillage radioélectrique subi, même si le brouillage est susceptible d'en compromettre le fonctionnement.

Privacy of communications may not be ensured when using this equipment.

La confidentialité des communications ne peut pas être garantie avec cet équipement.

### Exposure to radio frequency (RF) signals

This product is a radio transmitter and receiver. It is designed and manufactured not to exceed this emission limit for exposure to radio frequency (RF) energy set by the Ministry of Health (Canada), Safety Code 6. These limits are part of comprehensive guidelines and established permitted levels of RF energy for the general population. These guidelines are based on the safety standards previously set by international standard bodies. These standards include a substantial safety margin designed to assure the safety of all persons, regardless of age and health.

This device and its antenna must not be co-located or operating in conjunction with any other antenna or transmitter.

This device has been shown to be capable of compliance for localized specific absorption rate (SAR) for uncontrolled environmental / general public exposure limits specific in ANSI/IEEE C95.1-1992 and had been tested in accordance with the measurement procedures specified in IEEE 1528-2003.

This Class B digital apparatus complies with Canadian ICES-003. / CET appareil numérique de la classe B est conforme à la norme NMB-003 du Canada.

This product meets the applicable Industry Canada technical specifications. / Le présent matériel est conforme aux spécifications techniques applicables d'Industrie Canada.

### M900

- **Safety:** IEC 62368-1
- **Connectors**
  - **PoE:** RJ45 (8P8C)
  - **Power jack:** DC 5VDC@2A (power adapter not included in delivery)
- **Power.**
  - **Power over Ethernet (PoE):** IEEE 802.3, Class 2, 10/100 Base-T interface. If PoE is not available, the power adapter can be ordered separately:
  - **Power adapter:** (not included in delivery): Ten Pao SMPS power adapter, 5VDC 2A, model no. S018BAM0500200, Snom article no. 00004440 (US)

### M900 Outdoor

- **Safety:** IEC 62368-1
- **Connector:** PoE, RJ45 (8P8C)
- **Power:** Power over Ethernet (PoE). IEEE 802.3, Class 2, 10/100 Base-T interface.

# Introduction

In a typical telephony system, the M-series base station is connected to the local area network (LAN) which, in turn, is connected to a PBX or an IP Service Provider. The base station converts IP protocol to DECT protocol and transmits phone calls to and from the DECT handsets.

To be able to use the M-series DECT phones, the base station must be connected to your LAN and the handset(s) must be registered at the base station. This admin guide covers the manual configuration of one base station.

For information on multicell setup, see "M900 Multicell Deployment Guide";  
for information on provisioning settings, see "Provisioning Guide M900\_M700\_M300".

Both can be found at <https://service.snom.com>.

M-series base stations follow most Snom configuration and management schemes. It is recommended to have a local HTTP/HTTPS server for firmware updates, central configuration management, and hosting firmware files for base stations, handsets, and repeaters. Handsets and repeaters are updated over the air by the base station.

Normally the initialization of the base station is completely automatic, using DHCP. If the base station cannot discover a DHCP server in the subnet, you can set it up manually via its web interface. As a minimum you will need to enter the IP address, netmask, IP gateway, and DNS server. Your VoIP service provider or your network may require more data; please ask your provider or your network's administrator for the requisite input.

# Setting up

## Power sourcing

The **M900** is provided with both power and the network connection via PoE (Power over Ethernet). The PoE cable is connected to the RJ45 connector on the back of the unit (see Fig. 1, below). If your network does not have a PoE infrastructure, you can use the separately available power supply to provide power (see "Technical specifications" on page 8).

The **M900 Outdoor** version is provided with both power and the network connection via PoE (Power over Ethernet) **only**. For its installation instructions, see "Appendix 1 - Installing the M900 Outdoor" on page 78.

## M900 hardware setup

The M900 can be hung on the wall or placed on a desktop, shelf, cabinet, or on the floor as a standing unit.

1. Push the bracket on the back of the base station (Fig. 1) upward until it is released with a noticeable click (Fig. 2).
2. Lift the bracket off to gain access to the unit's Ethernet port and, if PoE is not available in your network, to the jack for the power supply (Fig. 3 and 4).

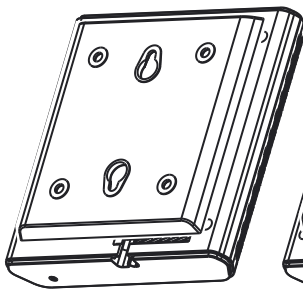

Fig. 1

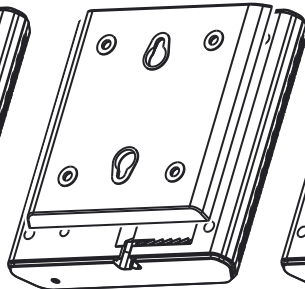

Fig. 2

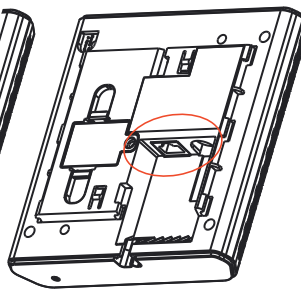

Fig. 3

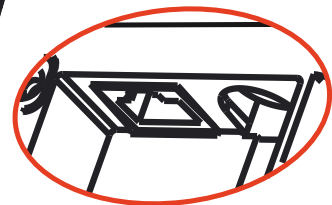

Fig. 4

3. Connect the Ethernet cable's RJ45 plug (Ethernet cable not included in delivery) to the RJ45 socket on the back of the base station; if applicable, connect the power adapter to the power jack.
4. Place the cable(s) in the two cable guide(s) (Fig. 5).

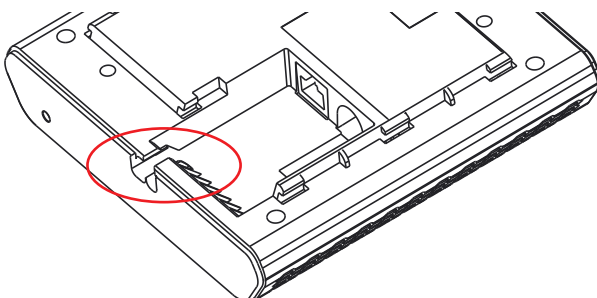

Fig. 5

- Put the bracket back on the base station and push it downward until it clicks securely into place. **Make sure it is securely affixed before you hang the M900 on the wall.**
- For optimal radio coverage, place the base station as high as possible, preferably at an angle other than vertical (Fig. 6) on a wall or pillar.

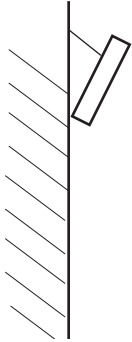

Fig. 6

**Note:**

- Do not mount the base station upside down as this would significantly reduce radio coverage.**
- If you use screws for wall mounting, make sure that they do not come into contact with the base station's casing as this might damage the PCB.**

**Wall mounting**

The bracket on the back of the M900 has two holes (Fig. 1) that can be used to hang the unit on two screws or hooks on a wall.

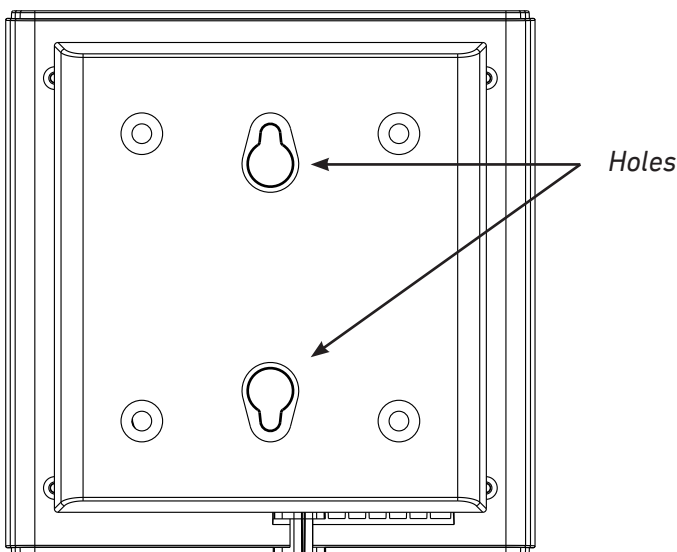

Fig. 1

**Note:** Screws/hooks and wall anchors are not included in the delivery. Use screws and wall anchors suitable for your wall.



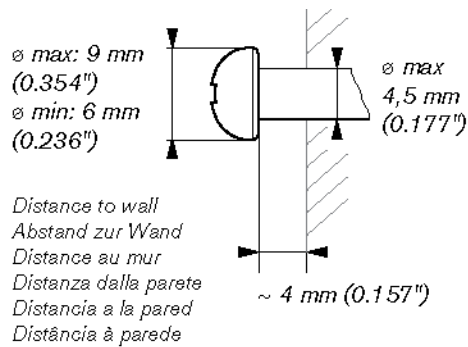

Fig. 2

1. Mark the centers of the two holes on the wall or pillar. The centers have to be 60 mm (2.3622") apart horizontally.
2. Drill the holes and insert the wall anchors flush to the wall.
3. Screw in the screws as shown in Fig. 2, above.
4. Place the two holes on the back of the device over the screws on the wall so that the LED is at the bottom edge of the device.

## User interface of the unit

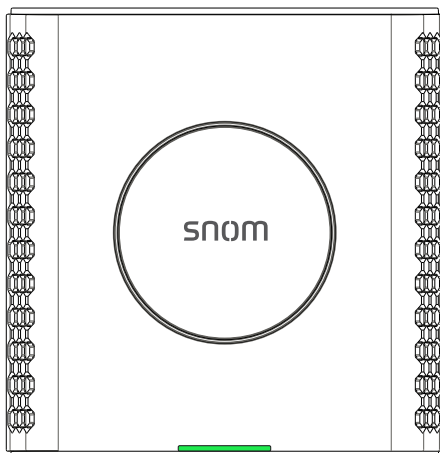

Fig. 1

### LED status indicator

At the bottom of the front of the unit there is a multicolored LED for status signaling (Fig. 1). After the PoE cable—or, if PoE is not available, the Ethernet cable and the power supply—is connected to the unit, the orange LED will begin to blink, indicating that the unit is booting. When the solid green LED comes on, the unit is connected to the network and is operational.

LED indicator	System state
Solid green	Operational
Blinking orange	Booting
Blinking red	Network or registration failure
Off	No power
Green, flashing rapidly	Software update in progress

The reset key on the bottom of the unit is used to return the settings to factory defaults. To perform a factory reset, press the key with an object like the end of a paper clip for at least 10 seconds.

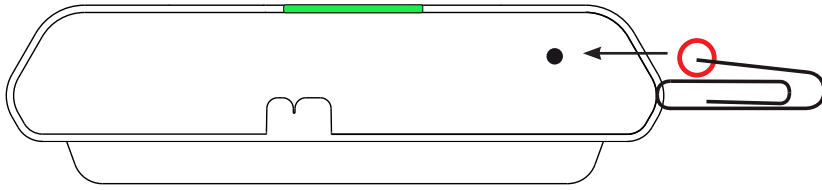

Fig. 7

# Configuring

To be able to use the M-series DECT phones, the base station must be connected to your network's or your VoIP service provider's PBX, and the handset(s) must be registered at the base station. This admin guide covers the manual configuration of the base station.

For information on provisioning settings, see "Provisioning Guide M900 Base Station"; for information on multicell setup, see the "M900 Multicell Deployment Guide". You can download them at <https://service.snom.com/>, DECT.

M-series base stations follow most Snom configuration and management schemes. It is recommended to have a local HTTP/HTTPS server for firmware updates, central configuration management, and hosting firmware files for base stations, handsets, and repeaters. Handsets and repeaters are updated over the air by the base station.

## Preliminary steps

Normally the initialization of the base station is completely automatic, using DHCP. If the base station cannot discover a DHCP server in the subnet, you can set it up manually via its web interface. As a minimum you will need to enter the IP address, netmask, IP gateway, and DNS server. Your VoIP service provider or your network may require more data; please ask your provider or your network's administrator for the requisite input.

### Finding the IP address of the base station

You can use any M-series handset (M65, M70, M80, M85, M90, M25) in the vicinity of the base station to find the base's IP address. The handset does not need to be registered at the base.

1. Connect the base station to your network and wait until the LED is green.
2. Press the menu key  on the handset, with the exception of the M25 where you press the center of the navigation key. The main menu screen (Fig. 1) will appear on the display.

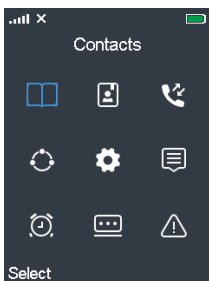

Fig. 1

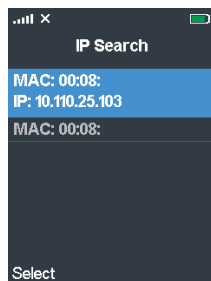

Fig. 2

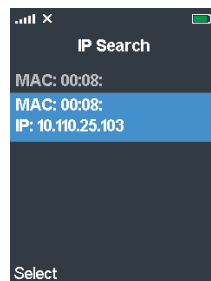

Fig. 3

3. Type **\*47\*** on the keypad. The **IP Search** screen opens (Fig. 2). If your handset has detected more than one base station within range, check the MAC address on the back of your base station and use the navigation key to select your base (Fig. 3).



## Opening the web user interface

1. Open a web browser on your PC. Enter the IP address, preceded by "http://" in the address bar (for example: http://192.168.10.115) and press ENTER.
2. Enter your user name and password in the pop-up window. The defaults for both are admin:

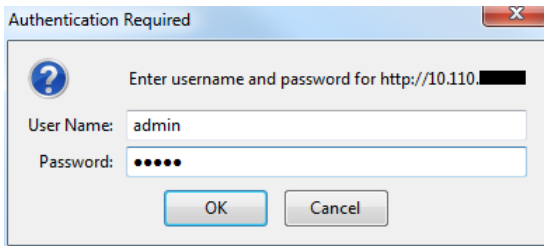

Default user name: admin  
Default password: admin

Fig. 4

3. Click on **OK**.

The **Home/Status** page opens, showing your system information. The vertical menu on the left side of the window is always the same, no matter which window happens to be open at the time. Click on a menu item to open that page.

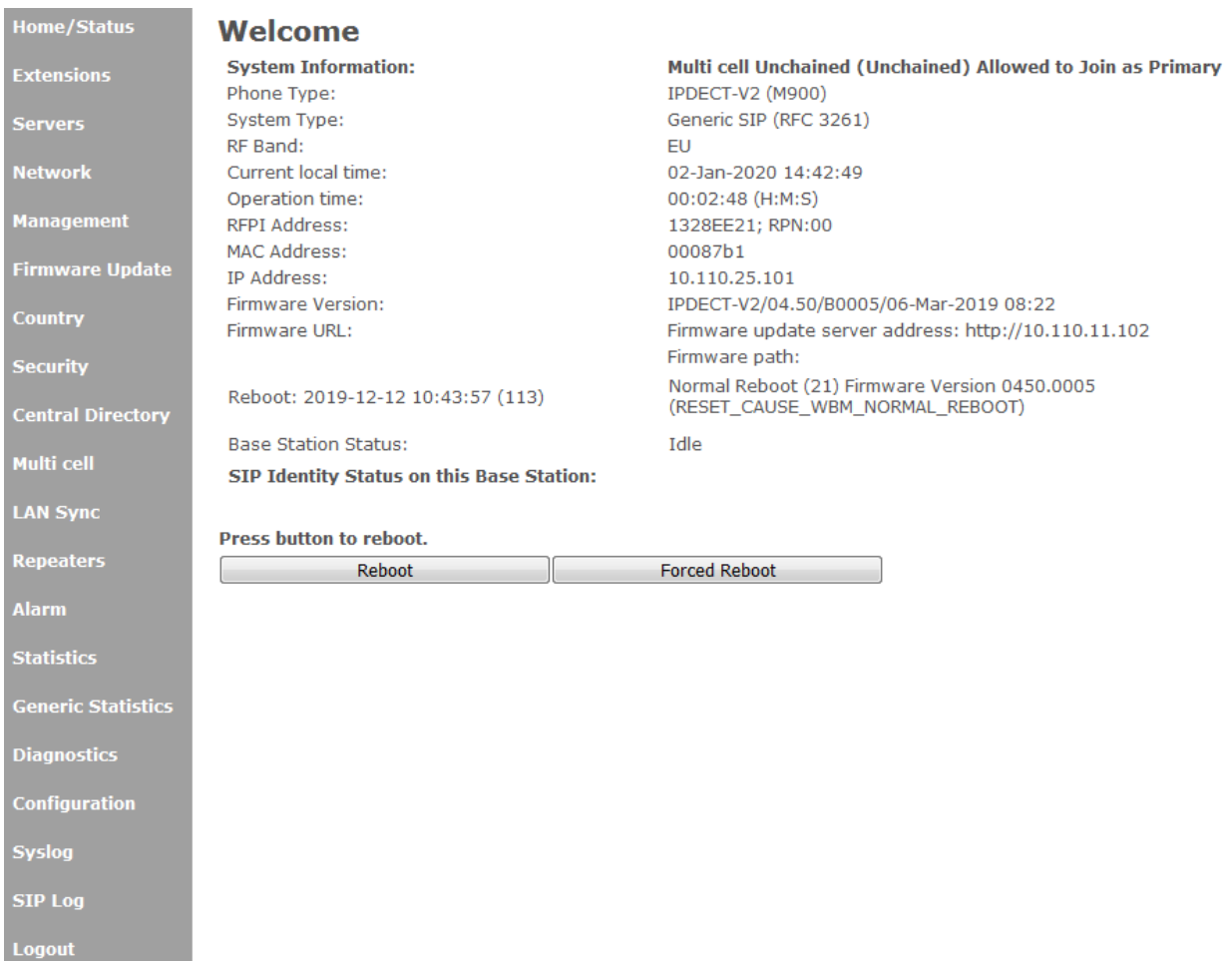

Fig. 5

**Note:** Before opening another page or closing the web user interface, click the **Save** button to save the setting(s) you have made or changed on any page.

## Initial settings

### Servers

During the initialization, the default server settings are loaded automatically. For a description of the settings, see "Servers" on page 48.

### Language, country, and time/date

The **Country** page contains drop-down menus for the selection of your country, a state or region within that country, if applicable, and the language to be used on the web interface of the base station.

In the default setting, the time zone and daylight saving time (DST) are set automatically so that the time and DST of the selected country and, if applicable, the selected region of the country will be used on the base station and the handsets (Fig. 1). The automatic settings can be disabled by unchecking the checkboxes for the settings **Set timezone by country/region** and **Set DST by country/region**; the manual settings are enabled simultaneously (Fig. 2).

For a description of the settings, see "Country/time settings" on page 59.

#### Selecting country, region, and language

##### Country/Time Settings

Select country:

State / Region:

Notes:

Select Language:

Time Server:

Allow broadcast NTP:

Refresh time (h):

Set timezone by country/region:

Timezone:

Set DST by country/region:

Daylight Saving Time (DST):

DST Fixed By Day:

DST Start Month:

DST Start Date:

DST Start Time:

DST Start Day of Week:

DST Start Day of Week Last in Month:

DST Stop Month:

DST Stop Date:

DST Stop Time:

DST Stop Day of Week:

DST Stop Day of Week Last in Month:

Fig. 1

##### js

Select country:

State / Region:

Notes:

Select Language:

Time Server:

Allow broadcast NTP:

Refresh time (h):

Set timezone by country/region:

Timezone:

Set DST by country/region:

Daylight Saving Time (DST):

DST Fixed By Day:

DST Start Month:

DST Start Date:

DST Start Time:

DST Start Day of Week:

DST Start Day of Week Last in Month:

DST Stop Month:

DST Stop Date:

DST Stop Time:

DST Stop Day of Week:

DST Stop Day of Week Last in Month:

Fig. 2

1. Select your country from the drop-down menu of **Select country** (Fig. 1).
2. For some countries like the US and Australia, state or region options affecting time zone and DST settings can also be selected. Select your state or region from the drop-down menu of **State/region**. If sections within a region use a different time than the time zone they are located in, the deviation will be mentioned in the text box of **Notes**.
3. Select the **language** for the web interface of the base station from the drop-down menu. The default is English.
4. If you don't want to use the time zone of the country/region selected in steps 1 and 2, uncheck the checkbox of **Set timezone by country/region** to disable the automatic setting and select the time difference to Coordinated Universal Time (UTC) manually from the drop-down menu of **Timezone** (Fig. 2).
5. If you don't want to use the DST setting of the country/region selected in steps 1 and 2, uncheck the checkbox of **Set DST by country/region** (Fig. 2). You can now deactivate DST or select the settings manually. For the description of the manual settings, see "Manual time and DST settings" on page 61.
6. Click **Save**.

## Extensions

To be able to use a handset, an extension must have been set up for it on the web interface of the base station, and the handset must be registered for the extension using one of two methods. On Snom corded desk phones, these extensions (or accounts) are called "identities". Please note:

- An extension/identity can only be assigned to one handset in your single-cell or multicell installation. Do not try to register more than one handset for an extension.
- Extension numbers must be unique, even when they are used on different SIP servers, regardless whether the servers are in your office network or provided externally by an IP provider.

### Setting up extensions

1. Click on **Extensions** to open the **Extensions** page.

#### Extensions

[Add extension](#)  
[Stop Registration](#)

Idx	IPEI	Handset State	Handset Type FW Info	FWU Progress	VoIP Idx	Extension	Display Name	Server	Server Alias	State
There are currently no extensions for server										

Fig. 1

2. Click on **Add extension** to open the **Add extension** page. Depending on your PBX, the information you need to enter will vary. **Handset** selection, **Extension** setting, and **Server** selection are mandatory. The remaining settings depend on the requirements of your PBX or VoIP provider and can be left blank, if nothing is required. Check with your IT administrator or service provider. Mandatory settings:
  - a. **Handset**. The default setting is **New Handset**. You can select an existing handset Idx from the drop-down menu.
  - b. Enter the extension number in the **Extension** text field.
    - If a mailbox has been set up for the extension (either internally on a server within your

network or externally by you IP provider), enter the mailbox extension number in the text field of **Mailbox Number** and, if no mailbox name is set, also in the text field of **Mailbox Name**. These requirements also apply when the mailbox extension number is the same as the extension number.

- If a PIN is required to listen to your VoiceMail, type it in the text field of **PIN**. Ask your IT administrator or IP provider for it. This PIN is not to be confused with the access code for registering the handset at the base station or the PIN for resetting the handset to factory values or for deregistering it from the base station.
- c. Select the server from the drop-down menu of **Server**.
  - d. Click on **Save**.

**Add extension**

Line name:

Handset:

Extension:

Authentication User Name:

Authentication Password:

Display Name:

XSI Username:

XSI Password:

PIN:

Mailbox Name:

Mailbox Number:

Server:

Call waiting feature:

BroadWorks Shared Call Appearance:

BroadWorks Feature Event Package:

UaCSTA:

Forwarding Unconditional Number:

Forwarding No Answer Number:    s

Forwarding on Busy Number:

Fig. 2

**Registering handsets - method 1**

1. After setting up the extension as shown in the preceding paragraph, click on the string of capital Fs underneath the **IPEI** header in the table on the **Extensions** page.

**Extensions**

[Add extension](#)  
[Stop Registration](#)

	Idx	IPEI	Handset State	Handset Type FW Info	FWU Progress		VoIP Idx	Extension	Display Name	Server	Server Alias	State
<input type="checkbox"/>	1	FFFFFFFF				<input type="checkbox"/>	1	7816		.snom.com	-201	
<a href="#">Check All / Uncheck All</a>						<a href="#">Check All Extensions / Uncheck All Extensions</a>						

With selected: [Delete Handset\(s\)](#) [Register Handset\(s\)](#) [Deregister Handset\(s\)](#) [Start SIP Registration\(s\)](#) [SIP Delete Extension\(s\)](#)

Fig. 3

2. Enter the IPEI of the handset.

**Handset**

Location: ANY

IPEI: FFFFFFFF

AC: 0000

Alarm Line: No Alarm Line Selected

Alarm Number:

Save Cancel

Fig. 4

**Handset**

Location: ANY

IPEI: 02523B

AC: 0000

Alarm Line: No Alarm Line Selected

Alarm Number:

Save Cancel

Fig. 5

**Note:** To find the IPEI, open the **Settings** menu of the handset, select **Status**, and scroll down to the IPEI at the end of the handset status. The IPEI consists of a string of 10 decimals and capital letters. Do not enter the colons grouping the characters of the string into twos.

- Click on **Save**. In the table on the **Extensions** page, the IPEI has been added under the IPEI header.
- Check the box to the left of the Idx and click on **Register Handset(s)**.

**Extensions**

[Add extension](#)  
[Stop Registration](#)

	Idx	IPEI	Handset State	Handset Type FW Info	FWU Progress		VoIP Idx	Extension	Display Name	Server	Server Alias	State
<input checked="" type="checkbox"/>	1	02523	Detached			<input type="checkbox"/>	1	7816		.snom.com	-201	

Check All / Uncheck All      Check All Extensions / Uncheck All Extensions

With selected: [Delete Handset\(s\)](#) **Register Handset(s)** [Deregister Handset\(s\)](#) [Start SIP Registration\(s\)](#) [SIP Delete Extension\(s\)](#)

Fig. 6

- Check the box to the left of the VoIP Idx and click on **Start SIP Registration(s)**.

**Extensions**

[Add extension](#)  
[Stop Registration](#)

	Idx	IPEI	Handset State	Handset Type FW Info	FWU Progress		VoIP Idx	Extension	Display Name	Server	Server Alias	State
<input type="checkbox"/>	1	02523	Detached			<input checked="" type="checkbox"/>	1	7816		.snom.com	-201	

Check All / Uncheck All      Check All Extensions / Uncheck All Extensions

With selected: [Delete Handset\(s\)](#) [Register Handset\(s\)](#) [Deregister Handset\(s\)](#) **Start SIP Registration(s)** [SIP Delete Extension\(s\)](#)

Fig. 7

The handset has been registered to use the extension. **Note:** To be able to use the handset, you also need to select **Register** in the **Connectivity** menu of the handset itself.

**Extensions**

[Add extension](#)  
[Stop Registration](#)

	Idx	IPEI	Handset State	Handset Type FW Info	FWU Progress		VoIP Idx	Extension	Display Name	Server	Server Alias	State
<input type="checkbox"/>	1	0253	Present@RPN00	M65 316.2	Off	<input type="checkbox"/>	1	7816		.snom.com	ser-fx-201	SIP Registered@RPN00

Check All / Uncheck All      Check All Extensions / Uncheck All Extensions

With selected: [Delete Handset\(s\)](#) [Register Handset\(s\)](#) [Deregister Handset\(s\)](#) [Start SIP Registration\(s\)](#) [SIP Delete Extension\(s\)](#)

Fig. 8

- Set up another extension (see "Setting up Extensions" on page 29, step 2) and repeat steps 1 - 5 for every handset.



### Registering handsets - method 2

For this method, you need to have all handsets within reach. Set up all extensions as described in "Setting up extensions" on page 22, then perform the following steps for each handset.

1. In the table on the Extensions page, check the box to the left of the Idx and then click on **Register Handset(s)**.

#### Extensions

[Add extension](#)  
[Stop Registration](#)

	Idx	IPEI	Handset State	Handset Type FW Info	FWU Progress		VoIP Idx	Extension	Display Name	Server	Server Alias	State
<input type="checkbox"/>	1	FFFFFFFFF				<input type="checkbox"/>	1	7816		.snom.com	-201	
<a href="#">Check All / Uncheck All</a>						<a href="#">Check All Extensions / Uncheck All Extensions</a>						
<i>With selected:</i> <a href="#">Delete Handset(s)</a> <a href="#">Register Handset(s)</a> <a href="#">Deregister Handset(s)</a> <a href="#">Start SIP Registration(s)</a> <a href="#">SIP Delete Extension(s)</a>												

Fig. 9

2. On the handset, select the **Connectivity** menu (Fig. 11).

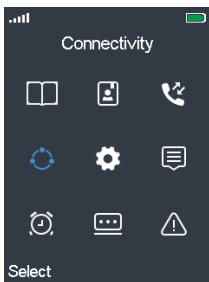

Fig. 10

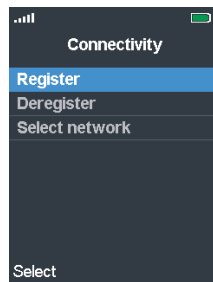

Fig. 11

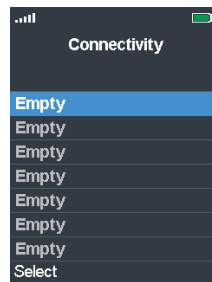

Fig. 12

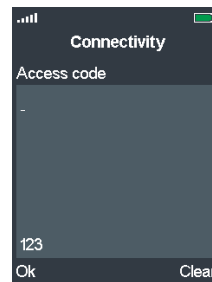

Fig. 13

3. Select **Register** (Fig. 11).
4. M65, M70, M80, M85, M90: Select the first field with the word **Empty** in it (Fig. 12). The M25 only supports one registration and doesn't show this screen.

**Note:** Fields that do not say "Empty", i.e., that have no text or a different text, already contain a registration; if you select one of those, you will be asked whether you want to overwrite the current registration.

5. Enter the access code and press the OK key.
6. In the table on the Extensions page, check the box to the left of the VoIP Idx and click on **Start SIP Registration(s)**.

#### Extensions

[Add extension](#)  
[Stop Registration](#)

	Idx	IPEI	Handset State	Handset Type FW Info	FWU Progress		VoIP Idx	Extension	Display Name	Server	Server Alias	State
<input type="checkbox"/>	1	FFFFFFFFF	Enabled			<input checked="" type="checkbox"/>	1	7816		.snom.com	-201	
<a href="#">Check All / Uncheck All</a>						<a href="#">Check All Extensions / Uncheck All Extensions</a>						
<i>With selected:</i> <a href="#">Delete Handset(s)</a> <a href="#">Register Handset(s)</a> <a href="#">Deregister Handset(s)</a> <a href="#">Start SIP Registration(s)</a> <a href="#">SIP Delete Extension(s)</a>												

Fig. 14

The handsets IPEI is added to the table, indicating that the handset is registered to use the extension, and the **State** column shows the SIP registration (Fig. 15).

**Extensions**

[Add extension](#)  
[Stop Registration](#)

	Idx	IPEI	Handset State	Handset Type FW Info	FWU Progress		VoIP Idx	Extension	Display Name	Server	Server Alias	State
<input type="checkbox"/>	1	0253:_____	Present@RPN00	M65 316.2	Off	<input type="checkbox"/>	1	7816		.snom.com	ser-fx-201	SIP Registered@RPN00

[Check All / Uncheck All](#)
[Check All Extensions / Uncheck All Extensions](#)

*With selected:* [Delete Handset\(s\)](#) [Register Handset\(s\)](#) [Deregister Handset\(s\)](#) [Start SIP Registration\(s\)](#) [SIP Delete Extension\(s\)](#)

Fig. 15

- Repeat steps 1 - 6 for all extensions.

**Selecting emergency alarm setting**

Emergency alarm settings: See "Emergency alarm" on page 31.

The majority of the features of the emergency alarm are available on handsets with a dedicated alarm key (the red key at the top of the handset), i.e., M70, M80, M85, and M90. For the M65 an alarm number can be specified which the handset will dial when the OK-/Confirm key on the idle M65 is pressed for three seconds (factory setting); the M25 does not have an emergency alarm.

**Handset (M70)**

IPEI:

Paired Terminal:

AC:

Alarm Line:

Alarm Number:

**Beacon Settings:**

Receive Mode:

Transmit Interval:

**Alarm Profiles:**

Profile	Alarm Type	<input type="checkbox"/>
Profile 0	Alarm Button	<input type="checkbox"/>
Profile 1	Alarm Button	<input type="checkbox"/>
Profile 2	Not configured	<input type="checkbox"/>
Profile 3	Not configured	<input type="checkbox"/>
Profile 4	Not configured	<input type="checkbox"/>
Profile 5	Not configured	<input type="checkbox"/>
Profile 6	Not configured	<input type="checkbox"/>
Profile 7	Not configured	<input type="checkbox"/>

Fig. 16

**Handset (M70)**

IPEI:

Paired Terminal:

AC:

Alarm Line:

Alarm Number:

**Beacon Settings:**

Receive Mode:

Transmit Interval:

**Alarm Profiles:**

Profile	Alarm Type	<input type="checkbox"/>
Profile 0	Alarm Button	<input type="checkbox"/>
Profile 1	Alarm Button	<input checked="" type="checkbox"/>
Profile 2	Not configured	<input type="checkbox"/>
Profile 3	Not configured	<input type="checkbox"/>
Profile 4	Not configured	<input type="checkbox"/>
Profile 5	Not configured	<input type="checkbox"/>
Profile 6	Not configured	<input type="checkbox"/>
Profile 7	Not configured	<input type="checkbox"/>

Fig. 17

- Open the **Extensions** page and click on the **IPEI** of the handset (Fig. 15).
- Select the handset's extension from the drop-down menu of **Alarm line** (Fig. 16).
- Enter the phone number to be called in case of an emergency alarm in the text field of **Alarm number**.
- Select one of the configured profiles by clicking on its checkbox (Fig. 17).
- Click on **Save**.

### Deregistering/deleting handsets and/or SIP registrations

#### Extensions

[Add extension](#)  
[Stop Registration](#)

	Idx	IPEI	Handset State	Handset Type FW Info	FWU Progress		VoIP Idx	Extension	Display Name	Server	Server Alias	State
<input checked="" type="checkbox"/>	1	0253	Present@RPN00	M65 316.2	Off	<input checked="" type="checkbox"/>	1	7816		.snom.com	ser-fx-201	SIP Registered@RPN00
<a href="#">Check All / Uncheck All</a>						<a href="#">Check All Extensions / Uncheck All Extensions</a>						
With selected: <a href="#">Delete Handset(s)</a> <a href="#">Register Handset(s)</a> <a href="#">Deregister Handset(s)</a> <a href="#">Start SIP Registration(s)</a> <a href="#">SIP Delete Extension(s)</a>												

Fig. 17

- To deregister one or more handsets, click the checkbox to the left of the **Idx** of the respective handset(s) and then on the link **Deregister Handset(s)**.
- To delete one or more handsets, click on the checkbox to the left of the **Idx** of the respective handset(s) and then on the link **Delete Handset(s)**.
- To delete the SIP registration of one or more extensions, click on the checkbox to the left of the **VoIP Idx** of the respective extensions(s) and then on the link **SIP Delete Extension(s)**.

### Registering M5 repeaters

The maximum number of repeaters per base station is 3 (three). In a single-cell system, the base station (the **DECT sync source**) will always be RPN00; the repeaters will be numbered RPN01, RPN02, and RPN03. In a multicell system, you can look up the RPNs of base stations and repeaters on the **Multicell** page of the web user interface.

There are two **DECT sync modes**, **Manual** and **Local Automatical**. Automatic sync mode is recommended for repeaters registered directly at the base station or - in a multicell system - directly at the primary or any secondary base station in the chain. When repeaters are daisy-chained to other repeaters, manual sync mode must be used.

**Note:** If you have changed the access code (AC) for registering handsets at the base station to a custom code, you must change it back to the default 0000 to be able to register repeaters.

#### Automatic registration

When this method is used, the repeater will look for the best base station signal, and the base station will automatically assign an RPN. This method is recommended for registering repeaters directly at the base station. To daisy-chain two or three repeaters, use manual registration (see page 29).

1. Open the **Repeaters** page.

#### Repeaters

<a href="#">Add Repeater</a>								
<a href="#">Refresh</a>								
<a href="#">Stop Registration</a>								
	Idx	RPN	Name/ IPEI	DECT sync source	DECT sync mode	State	FW Info	FWU Progress

Fig. 1

2. Click on **Add Repeater** (Fig. 1).

3. Enter a name for the repeater, for example a consecutive number or its location. This name will be listed in the **Name/IPEI** column on the **Repeater** page (Fig. 3); if you do not enter a name, the IPEI will be listed instead.

**Repeater**

Name:

DECT sync mode:

Fig. 2

4. Select **Local Automatical** from the DECT sync mode drop-down menu.
5. Click on **Save**.

**Repeaters**

[Add Repeater](#)

[Refresh](#)

[Stop Registration](#)

	Idx	RPN	Name/ IPEI	DECT sync source	DECT sync mode	State	FW Info	FWU Progress
<input type="checkbox"/>	1		M5_01/ FFFFFFFF	RPNF0 (-∞dBm)	Local Automatical			

[Check All / Uncheck All](#)

With selected: [Delete Repeater\(s\)](#) [Register Repeater\(s\)](#) [Deregister Repeater\(s\)](#)

Fig. 3

6. Connect the repeater to a power outlet.
7. Press the reset tab on the back of the repeater for approx. 2 seconds until the LED blinks red briefly and then switches to double green flashes.

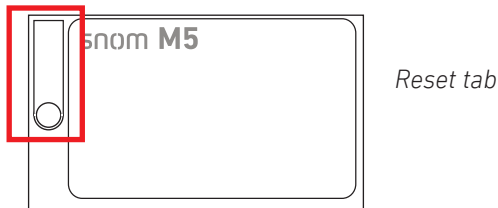

Fig. 4

8. On the **Repeater** page, check the box to the left of the Idx and then click on **Register Repeater(s)**.

**Repeaters**

[Add Repeater](#)

[Refresh](#)

[Stop Registration](#)

	Idx	RPN	Name/ IPEI	DECT sync source	DECT sync mode	State	FW Info	FWU Progress
<input checked="" type="checkbox"/>	1		M5_01/ FFFFFFFF	RPNF0 (-∞dBm)	Local Automatical	Enabled		

[Check All / Uncheck All](#)

With selected: [Delete Repeater\(s\)](#) [Register Repeater\(s\)](#) [Deregister Repeater\(s\)](#)

Fig. 5

Upon successful registration, the **Repeater** page will show the repeater's and the base station's RPNs, the repeater's IPEI, and the state as "Enabled".

### Repeaters

Add Repeater

Refresh

Stop Registration

	Idx	RPN	Name/ IPEI	DECT sync source	DECT sync mode	State	FW Info	FWU Progress
<input type="checkbox"/>	1	RPN01	M5_01/ 016E8	RPN00 (-34dBm)	Local Automatical	Enabled	33	Off

Check All / Uncheck All

With selected: Delete Repeater(s), Register Repeater(s) Deregister Repeater(s)

Fig. 6

### Manual registration

This method must be used for daisy-chaining two or three repeaters. The RPN for the repeater as well as its DECT sync source must be selected manually from the respective drop-down menus.

1. Open the **Repeaters** page (Fig. 6, above).
2. Click on **Add Repeater**.
3. Enter a name for the repeater, for example a consecutive number or its location. If you do not enter a name, the IPEI will be listed (Fig. 7).

#### Repeater

Name:

DECT sync mode:

Fig. 7

4. Select **Manually** from the DECT sync mode drop-down menu (Fig. 7). The RPN/DECT sync source table appears (Fig. 8).

#### Repeater

Name:

DECT sync mode:

RPN	DECT sync source
<input type="text" value="RPN02"/>	<input type="text" value="RPN01"/>

Fig. 8

5. Select the **DECT sync source** from the drop-down menu. In the example (Fig. 9, below), the DECT sync source of the second repeater is the first repeater from Fig. 6, above, therefore RPN01 is selected.

#### Repeater

Name:

DECT sync mode:

RPN	DECT sync source
<input type="text" value="RPN01"/>	<input type="text" value="RPN01"/>

Fig. 9

6. Select the RPN from the drop-down menu of **RPN**.

**Repeater**

Name:

DECT sync mode:

---

RPN	DECT sync source
<input type="text" value="RPN01"/>	<input type="text" value="RPN01"/>
<input type="text" value="RPN01"/>	
<input type="text" value="RPN02"/>	
<input type="text" value="RPN03"/>	

Fig. 10

- Click on **Save**.
- Connect the repeater to a power outlet.
- Press the reset tab on the back of the repeater (see Fig. 4 on the preceding page) for approx. 2 seconds until the LED blinks red briefly and then switches to double green flashes.
- On the **Repeater** page, check the box to the left of the Idx of both or all three repeaters in the chain and then click on **Register Repeater(s)** (Fig. 10).

**Repeaters**

[Add Repeater](#)

[Refresh](#)

[Stop Registration](#)

	Idx	RPN	Name/ IPEI	DECT sync source	DECT sync mode	State	FW Info	FWU Progress
<input checked="" type="checkbox"/>	1	RPN01	M5_01/ 016E8	RPN00 (-54dBm)	Local Automatical	Present@RPN00	33	Off
<input checked="" type="checkbox"/>	2	RPN02	M5-02/ FFFFFFFF	RPN01 (-∞dBm)	Manually	Enabled		

[Check All / Uncheck All](#)

With selected: [Delete Repeater\(s\)](#) [Register Repeater\(s\)](#) [Deregister Repeater\(s\)](#)

Fig. 10

Upon successful registration, the **Repeater** page will show the RPNs of the newly added repeater and its DECT sync source, its IPEI, and the state as "Enabled".

**Repeaters**

[Add Repeater](#)

[Refresh](#)

[Stop Registration](#)

	Idx	RPN	Name/ IPEI	DECT sync source	DECT sync mode	State	FW Info	FWU Progress
<input type="checkbox"/>	1	RPN01	M5_01/ 016E8	RPN00 (-54dBm)	Local Automatical	Present@RPN00	33	Off
<input type="checkbox"/>	2	RPN02	M5-02/ 016E8	RPN01 (-28dBm)	Manually	Enabled	33.3	Off

[Check All / Uncheck All](#)

With selected: [Delete Repeater\(s\)](#) [Register Repeater\(s\)](#) [Deregister Repeater\(s\)](#)

Fig. 11

## Emergency alarm

Seven emergency alarm profiles can be configured on this page. All configured emergency alarm settings can be selected individually for any handset registered at the base station if that handset has an emergency alarm function. After an emergency alarm profile has been configured in this menu, it can be selected for individual handsets on the handset page.

**Note:** All features of the emergency alarm settings are available on the M70, M80, M85, and M90. The M65 can be enabled to send an alarm call to the specified alarm number using the factory settings; the M25 does not have an emergency alarm.

### Alarm

Idx	Profile Alias	Alarm Type	Alarm Signal	Stop Alarm from Handset	Trigger Delay	Stop Pre-Alarm from Handset	Pre-Alarm Delay	Howling
0		Alarm Button ▾	Call ▾	Disabled ▾	0	Enabled ▾	30	Enabled ▾
1		Disabled ▾	Call ▾	Enabled ▾	0	Enabled ▾	0	Disabled ▾
2		Disabled ▾	Call ▾	Enabled ▾	0	Enabled ▾	0	Enabled ▾
3		Disabled ▾	Call ▾	Enabled ▾	0	Enabled ▾	0	Disabled ▾
4		Disabled ▾	Call ▾	Enabled ▾	0	Enabled ▾	0	Disabled ▾
5		Disabled ▾	Call ▾	Enabled ▾	0	Enabled ▾	0	Disabled ▾
6		Disabled ▾	Call ▾	Enabled ▾	0	Enabled ▾	0	Disabled ▾
7		Disabled ▾	Call ▾	Enabled ▾	0	Enabled ▾	0	Disabled ▾

Save Cancel

- **Profile alias.** Optional name for alarm profile; will be added to profile number in parentheses.
- **Alarm type.** Select **Alarm Button** from the drop-down menu to enable the alarm feature. Default setting: Disabled.
- **Alarm signal.** The **Call** setting is mandatory. When the alarm button on the handset is pressed, the handset will call the phone number specified in the handset's Alarm settings (see "Selecting emergency alarm setting" on page 26).

The following settings apply to the M70, M80, M85, and M90. The M65 uses the default settings regardless of the setting, except for **Howling** which is not available on the M65.

- **Stop Alarm from Handset.** This setting establishes whether or not an alarm can be cancelled from the handset. Default setting: Enabled.
- **Trigger Delay.** Enter the number of seconds from the moment the handset's alarm button is pressed that the handset will wait before calling the alarm number or, if a pre-alarm delay has also been configured, before the pre-alarm delay is triggered. Default setting: 0.
- **Stop Pre-Alarm from Handset.** This setting establishes whether or not a pre-alarm can be cancelled from the handset. Default setting: Enabled.
- **Pre-Alarm Delay.** Enter the number of seconds from the moment the handset's alarm button is pressed that the handset will wait before calling the alarm number. The display will show the "Pre-alarm triggered" message, and the emergency ringer, if set, will be played. Default setting: 0.
- **Howling** (not available on M65). This setting establishes whether or not the handset will emit a howl while it is dialing the emergency number. Default setting: Disabled.

# Central phone directory

The central directory is accessible from all handsets registered at the same base station or in the same multicell installation. The central directory can be a phone list downloaded to the base station or an external source like the company LDAP register. It is not possible to add, delete, or edit central directory entries - whether downloaded or on an external source - on the base station's web interface or on the handsets.

**Central Directory**

Location: Local

Server: Local

Filename: LDAP Server

Phonebook reload interval (s): XML Server

Save

---

**Import Central Directory:**

Filename:  No file selected.

Last imported directory: phonebook3

Fig. 1

## Local central directory

The **local** central directory is a phone list downloaded to the base station or to the primary base station in a multicell installation. The directory can contain up to 3,000 entries, maximum file size 100kb.

**Note:** The list cannot be edited on the base station's web interface or on the handsets.

If you need to edit existing entries or if you want to add or delete entries, you must do so in the original file and download it anew. The entire saved file is overwritten every time you load a file to the central directory.

## Preparing the phone directory file

The local central directory loaded onto the base station must adhere to one of two formats. If there is only one phone number for every name, you can use list type 1. If some of the entries have more than one phone number associated with a name, use list type 2.

### List type 1

This is a text file containing a list of entries with comma-separated values. Each entry consists of a name and a phone number. Save the file on your PC or on a server as a normal text file (\*.txt).

Valid values:

- Name: A total of 23 characters.
  - The comma (,) is not allowed because it serves to separate the name and number values of each entry. Entries with more than one comma-separator will be discarded without warning.
  - Names with more than 23 characters will be truncated.



- The dot (.) and parentheses () are not allowed.
- Number: A total of 21 characters.
  - Valid characters: Digits 0 to 9 and the symbol +. Numbers with invalid characters will be discarded without warning.
  - Numbers with more than 21 characters will be discarded without warning.

Examples for valid entries:

Mark,9345  
 Jack,+493011111111  
 Mary Miller,9856  
 Miller Mary,9856  
 Dr Smith,9175550145  
 Tim Meier,040111111111  
 Jack Tim-Burton,7111

Examples for invalid entries that will be discarded:



Dr. Smith,917-5550145	<i>(dot after Dr is invalid)</i>
Dr Smith,(917)5550145	<i>(brackets are invalid)</i>
Jack,030-11111111	<i>(hyphen in number is invalid)</i>
Jack,030 11111111	<i>(space within number is invalid)</i>
Miller,Mary,9856	<i>(comma separating last and first name is invalid)</i>

## List type 2

This is a list using the format of XML elements. Each entry consists of a name and up to three phone numbers. **If a name has less than three numbers, do not remove the XML element(s)** themselves; just leave the value(s) blank. Save the file on your PC or on a server as "all types" (\*.\*) or as a text file (\*.txt).

Three phone numbers per name are possible. If more than one number is available for a given name, they can be selected by pressing the right navigation key on the handset.



**Note:** Type the phone number with any required prefixes (area code, country code, operator/auto attendant, etc.). Only the digits 0 to 9 are allowed; do not use spaces, parentheses, punctuation, or other characters between the digits.

- **Work.** This is interpreted by the handset as the work phone number represented by the  symbol. If entered, the work number is the number presented by the handset when you select the name.
- **Mobile.** This is interpreted by the handset as the mobile phone number represented by the  symbol. If entered and if there is no office number, the mobile number is the number presented by the phone when you select the name.
- **Home.** This is interpreted by the handset as the home phone number represented by the  symbol. If there are no office or mobile numbers, the home number is presented by the handset when you select the name.

Required elements:

```
<IPPhoneDirectory>
<DirectoryEntry>
<Name></Name>
<Telephone></Telephone>
<Office></Office>
<Mobile></Mobile>
</DirectoryEntry>
</IPPhoneDirectory>
```

The indentations in the following example, a phone list with five names, are only for demonstration purposes to set the individual entries apart.

<pre>&lt;IPPhoneDirectory&gt;   &lt;DirectoryEntry&gt;     &lt;Name&gt;Name1&lt;/Name&gt;     &lt;Telephone&gt;phone number1&lt;/Telephone&gt;     &lt;Office&gt;office phone number1&lt;/Office&gt;-&gt;     &lt;Mobile&gt;mobile phone number1&lt;/Mobile&gt;   &lt;/DirectoryEntry&gt;</pre>	<p><i>Work (office) number is default number and shown first</i></p>	
<pre>  &lt;DirectoryEntry&gt;     &lt;Name&gt;Name2&lt;/Name&gt;     &lt;Telephone&gt;&lt;/Telephone&gt;     &lt;Office&gt;office phone number2&lt;/Office&gt;     &lt;Mobile&gt;&lt;/Mobile&gt;   &lt;/DirectoryEntry&gt;</pre>	<p><i>Work number is default number and shown first</i></p>	
<pre>  &lt;DirectoryEntry&gt;     &lt;Name&gt;Name3&lt;/Name&gt;     &lt;Telephone&gt;phone number3&lt;/Telephone&gt;     &lt;Office&gt; office phone number3 &lt;/Office&gt;     &lt;Mobile&gt;&lt;/Mobile&gt;   &lt;/DirectoryEntry&gt;</pre>	<p><i>Work number is default number and shown first</i></p>	
<pre>  &lt;DirectoryEntry&gt;     &lt;Name&gt;Name4&lt;/Name&gt;     &lt;Telephone&gt;phone number4&lt;/Telephone&gt;     &lt;Office&gt;&lt;/Office&gt;     &lt;Mobile&gt; mobile phone number4&lt;/Mobile&gt;   &lt;/DirectoryEntry&gt;</pre>	<p><i>No work number, mobile number is shown</i></p>	
<pre>  &lt;DirectoryEntry&gt;     &lt;Name&gt;Name5&lt;/Name&gt;     &lt;Telephone&gt;phone number5&lt;/Telephone&gt;     &lt;Office&gt;&lt;/Office&gt;     &lt;Mobile&gt; &lt;/Mobile&gt;&gt;   &lt;/DirectoryEntry&gt;</pre>	<p><i>No work or mobile number, home phone number is shown</i></p>	

## Downloading the phone directory file onto base station

1. After preparing and saving the file as described in "Preparing the Phone Directory File", click the **Browse** button (Fig. 1) and select the file on your PC or server (Fig. 2). The name of the file will appear to the right of the **Browse** button (Fig. 3).

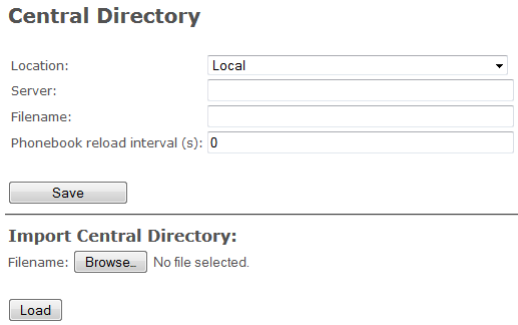

Fig. 1

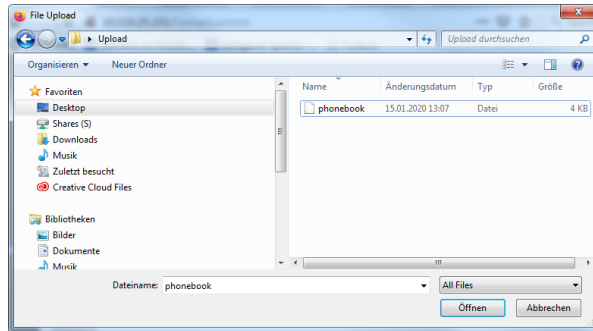

Fig. 2

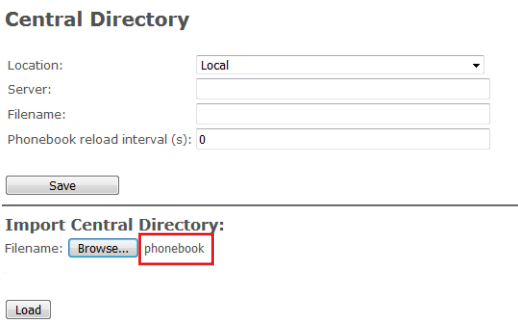

Fig. 3

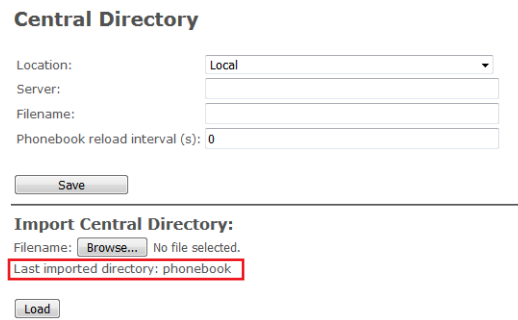

Fig. 4

2. Click on **Load** (Fig. 3).
3. You may need to reboot the base station to make sure that the changes take effect.

After the file has been downloaded to the base station, the name of the file is shown in the line "Last imported directory" (Fig. 4). You can view the contents of the imported file on the registered handsets, but not on the base station.

### Polling from external directory server

1. After preparing and saving the file as described in "Preparing the phone directory file" on page 32, upload the file to a server.
2. Enter the server's URL into the text field of **Server**.



3. Enter the name of the file into the text field of **Filename**.
4. Enter the number of seconds between downloads of the file into the text field of **Phonebook reload intervals (s)**. We advise against setting an interval of less than 1800 seconds (30 minutes) as it will increase traffic considerably.
5. Click **Save**.

# LDAP

On the **Central Directory** page, select **LDAP** from the drop-down menu of **Location** (see Fig. 1 on page 32) to open the LDAP server menu (Fig. 1, below). After saving your input, you may want to reboot the base station to make sure that the changes take effect.

Fig. 1

Fig. 2

## Settings:

- Server: IP address of the LDAP server
- Port: Server port for LDAP
- Sbase: This setting specifies the LDAP search base (the distinguished name of the search base object) which corresponds to the location in the directory from which the LDAP search is requested to begin. The criteria depend on the configuration of the LDAP server.
- LDAP Filter: LDAP name filter is the search criteria for name look-ups. The format of the search filter is compliant to the standard string representations of LDAP search filters (RFC 2254). The default value is blank.
- Bind: Specifies the bind "username" for LDAP servers when the handset connects to the server. If the server allows anonymous binds, you can leave the setting blank.
- Password: Specifies the bind "password" for LDAP servers. If the server allows anonymous binds, you can leave the setting blank.
- Virtual Lists: If your LDAP server does not support server-side result pagination and sorting (VLV extension), select "disabled" from the drop-down list.
- Handset identity settings.
  - Name: Select the LDAP name attribute from the drop-down menu. The options are cn and sn+givenName. The default setting is cn.
  - LDAP number attributes: The attributes telephoneNumber, mobile, and homephone are preset.

# Firmware update

When first installing the base station, Snom recommends updating to the latest firmware version. Please go to <https://service.snom.com/> to see if a new version is available and to download it.

You can either use the Snom M series update server or download the files to your own server and update the firmware from there.

**Note:** We recommend to always operate the base station and the connected wireless devices with the same firmware version.

Although it is possible to update an active live system, we cannot guarantee its uninterrupted functionality. We therefore recommend performing wireless updates when the whole system is idle.

## Considerations before updating

- On average, it takes 10 - 15 minutes to transmit the firmware file to the wireless devices, but it could take up to 60 minutes depending on traffic (voice traffic has priority).
- Using a handset will pause the transfer process to it. It will continue once the handset is back in idle mode.
- Once the firmware has been transferred, the actual update of each wireless device takes approx. one minute.
- The M900 can update up to 10 wireless devices at a time. If more devices are registered with the base, they will be updated successively.

**Note:** The base station selects the devices for firmware transfer randomly. It is not possible to assign priority to certain devices.

- Repeaters will start updating automatically when there are no ongoing calls, resulting in a service interruption of approx. one minute.
- Multicell installations.
  - The M900 will update all handsets in range, including devices registered on another base station.
  - When a user moves from within the range of one base station to another, the update will continue as long as sufficient update capacity is available.
  - When a multicell installation is fully occupied with firmware transfers, handover/roaming will fail, i.e., active calls may be lost.
  - When an update is initiated on one base station, all base stations will perform an update.

## Updating manually

Manual updates are performed in several steps: Downloading the update files for registered wireless devices to the base station and transmitting them from the base station to the devices, updating the base station, and updating the handsets by placing them in their chargers.

## Using Snom's update server

At <https://service.snom.com> click **HowTo's** (Fig. 1). In the menu on the left side, click the arrows of **How-to articles** and **DECT Solution How-to**, then select bullet points **How to update M300,M700,M900 DECT Base Station** and **How to update M-Series DECT handsets** for the descriptions on how to update and for downloading the latest firmware versions to your device(s).

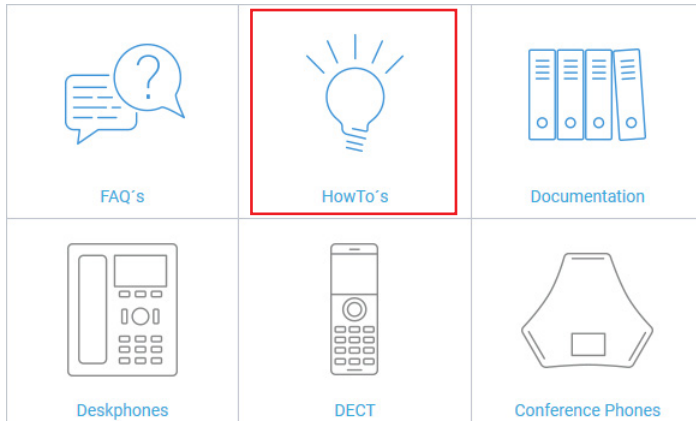

Fig. 1

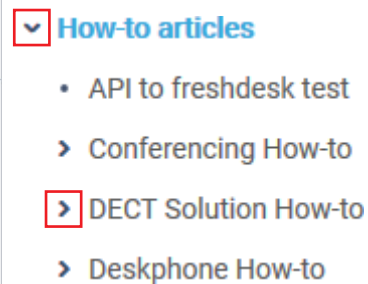

Fig. 2

## Using your own server

Before starting the update, you must download all required files and save them in folders using the exact structure described below.

Do not rename the update files as the base station will look for file names that adhere to the M-series naming scheme. All M-series product names start with a capital M, followed by one to three numerals. The names of the firmware files also start with the capital M and are followed by one to three numerals, i.e., M900, M70, M5, etc. The product name is followed by the underscore \_ which, in turn, is followed by a small v and the three-digit firmware version preceded by a zero, i.e., 0410, 0450, etc.

Examples:

- The update file for updating the M900 to version 450 must be named **M900\_v0450.fwu**.
- The update file for updating the M70 to version 450 must be named **M70\_v0450.fwu**.

### Downloading update files to your server

1. Set up a folder for each M-series product on your http server.

Name	Date modified	Type
M5	23.01.2020 09:53	File folder
M65	23.01.2020 09:54	File folder
M70	23.01.2020 09:54	File folder
M80	23.01.2020 09:54	File folder
M85	23.01.2020 09:54	File folder
M90	23.01.2020 09:54	File folder
M900	23.01.2020 09:55	File folder

**Note:** Linux/Unix based HTTP servers are case-sensitive. Since all M-series product names start with a capital M, the names of the folders must also start with a capital M, i.e., M900, M70, etc. Naming the folders m900, m70, etc. will cause the downloads to fail.

- Download the firmware file for each product you want to update into the respective folder. It is possible to store multiple firmware versions in a product folder; it is therefore not necessary to delete older firmware versions before downloading.

Name	Date modified	Type
M900_v0410.fwu	07.10.2019 16:51	FWU File
M900_v0450.fwu	01.03.2019 15:28	FWU File
M900_v0480.fwu	23.01.2020 10:11	FWU File

### Downloading update files to base station and transmitting to wireless devices

#### Firmware Update Settings

Firmware update server address:

Firmware path:

Terminal file path:

Type	Required version	Required branch	Voice prompts
Update Base Stations	<input type="text" value="450"/>	<input type="text" value="5"/>	
M70	<input type="text" value="450"/>	<input type="text" value="5"/>	
M80	<input type="text" value="450"/>	<input type="text" value="5"/>	
M90	<input type="text" value="450"/>	<input type="text" value="5"/>	
8930g	<input type="text" value="0"/>	<input type="text" value="0"/>	<input type="text"/>
M5	<input type="text" value="0"/>	<input type="text" value="0"/>	

- Open the web user interface of the base station and click on **Firmware Update** in the menu on the left side.
- In the section **Firmware Update Settings**, enter the address of your server in the text field of **Firmware update server address**.
- Enter the firmware path in the text field of **Firmware path** or leave blank, depending on your setup.
- The **Type** section lists all types of the wireless devices currently registered at the base, i.e., M70, M80, M5, etc. Any types of device not currently registered will not be listed. Enter the three-digit firmware version, i.e., 410, 450, etc., in the text field of each respective wireless product.
- Click on **Save/Start Update**. The base station will download the firmware and transmit it to the wireless devices. You can monitor the progress of the transfer to each registered handset on the **Extensions** page.
  - Handsets will not perform the update until the next time they are placed in the charger.

**Note:** On average, it takes 10 - 15 minutes to transmit the firmware file to the handset, but it could take up to 60 minutes depending on traffic (voice traffic has priority).

The transmission of the file to the handset will pause when the handset is used and continue as soon as it is idle again.

	Idx	IPEI	Handset State	FW Info	FWU Progress
<input type="checkbox"/>	0	018870DF2A	Present@RPN00	08/08/14 14:48	6%

Progress of firmware transfer in %; LED on handset is blinking red.

	Idx	IPEI	Handset State	FW Info	FWU Progress
<input type="checkbox"/>	0	018870DF2A	Present@RPN00	08/08/14 14:48	Verifying 27%

Firmware has been transferred and is being verified (progress in %).

	Idx	IPEI	Handset State	FW Info	FWU Progress
<input type="checkbox"/>	0	018870DF2A	Present@RPN00	08/08/14 14:48	Waiting for charger

Firmware transfer has been completed; update will start the next time the handset is placed in the charger.

- b. Repeaters will perform the update as soon as there are no active calls in the system.

### Updating the base station

- In the Update Base Stations section, click one of the radio buttons. The default is **Update this Base Station Only**.
- Enter the three-digit firmware version for updating the base station in the text field of **Required Version**, i.e., 410, 450, etc.
- Click on **Start Update**.

### Updating registered handsets

You have provided the firmware to the handsets registered at the base station in steps 4 and 5, above. The update of each handset will be performed the next time it is placed in the charger and will take approximately one minute.

- Place the handset in the charger to start the firmware update. The LED will flash rapidly, first green, then red.

If the update was successful, the handset will turn on again, and the web interface will indicate the completion of the update and the current firmware version on the handset.

	Idx	IPEI	Handset State	FW Info	FWU Progress
<input type="checkbox"/>	0	018870DF2A	Present@RPN00	318.9	Complete

## Provisioning updates

Please see the **Provisioning Guide M900/M700/M300** at <https://service.snom.com>.



# Description of settings

## Home/Status

The Home/Status page contains the summary of current operating condition and the settings of the base station and the handsets registered at the base station. It also contains the buttons for rebooting the base station.

### Welcome

**System Information:**

Phone Type:

System Type:

RF Band:

Current local time:

Operation time:

RFPI Address:

MAC Address:

IP Address:

Firmware Version:

Firmware URL:

Reboot: 2019-08-15 14:03:37 (50)

Reboot: 2019-08-15 13:52:33 (49)

Reboot: 2019-08-15 11:24:24 (48)

Reboot: 2019-08-15 11:08:42 (47)

Reboot: 2019-08-15 09:46:10 (46)

Reboot: 2019-08-14 17:14:19 (45)

Base Station Status:

**SIP Identity Status on this Base Station:**

80800@.snom.com

7777@.snom.com

7771@.snom.com

**Multi cell Disabled**

IPDECT-V2 (M900)

Generic SIP (RFC 3261)

EU

15-Aug-2019 14:04:43

00:00:50 (H:M:S)

1328 - ; RPN:00

00087b1

10.110.

IPDECT-V2/04.50/B0005/06-Mar-2019 08:22

Firmware update server address: http://10.110.

Firmware path:

Normal Reboot (21) Firmware Version 0450.0005 (RESET\_CAUSE\_WBM\_NORMAL\_REBOOT)

Power Loss (80) Firmware Version 0450.0005 (RESET\_CAUSE\_HARDWARE\_RESET)

Normal Reboot (21) Firmware Version 0450.0005 (RESET\_CAUSE\_WBM\_NORMAL\_REBOOT)

Normal Reboot (21) Firmware Version 0450.0005 (RESET\_CAUSE\_WBM\_NORMAL\_REBOOT)

Power Loss (80) Firmware Version 0450.0005 (RESET\_CAUSE\_HARDWARE\_RESET)

Normal Reboot (21) Firmware Version 0450.0005 (RESET\_CAUSE\_WBM\_NORMAL\_REBOOT)

Idle

Status: OK

Status: OK

Status: OK

Press button to reboot.



Fig. 1

Description of information on this page:

- System information: This base station's current multicell state (disabled, primary base station in multicell installation, secondary base station in multicell installation).

### Welcome

System Information: Multi cell Ready(Keep Alive) Primary

### Welcome

System Information: Multi cell Ready(Keep Alive) Secondary

Fig. 2

- Phone type: IP DECT
- System type: Custom configuration, if any. Default: Generic SIP (RFC 3261)
- RF band: Depending on location (EU, US, LATAM)
- Current local time, depending on country/time settings

- Operation time: Counter - time elapsed since last reboot of base
- RFPI address: RFPI: The Radio Fixed Part Identity is a unique identifier frequently transmitted by the base station.
- MAC address: The media access control (MAC) address is a unique identifier assigned by the manufacturer.
- IP address: The Internet Protocol address assigned by the network the base station is located in.
- Reboot: Date, time, and cause of the last six reboots (e.g., normal reboot, power loss)
- Firmware version: Contains the version, e.g. 04.50, and the branch, e.g. B0005.
- Firmware URL: The address of the server from which firmware updates are downloaded.
- Base station status: In use or Idle
- SIP identity status on this base station. This is the status of the handsets registered and currently present at this base station. Note: Handsets that are currently turned off are not shown; you can still view them on the Extensions page, showing their state as "detached". Error messages may differ, depending on the setup of your PBX.
- Reboot button (Fig. 1): Clicking this button will initiate a reboot as soon as the base station is idle, i.e., when there are no current calls, handsets accessing the directory, or ongoing firmware updates.
- Forced reboot button (Fig. 1): Clicking this button will initiate an immediate reboot; active calls, firmware updates, and directory access from all handsets will be terminated immediately.

## Extensions

This page has three subpages, **Add Extension**, **Edit Extension**, and **Handset**. Setting up extensions and registering handsets to extensions: See "Extensions" on page 22 ff.

**Note:**

- An extension/identity can only be assigned to one handset in your single-cell or multicell installation. Do not try to register more than one handset for an extension.
- Extension numbers must be unique, even when they are used on different SIP servers, regardless whether the servers are in your office network or provided externally by an IP provider.

### Extensions

[Add extension](#)  
[Stop Registration](#)

	Idx	IPEI	Handset State	Handset Type FW Info	FWU Progress		VoIP Idx	Extension	Display Name	Server	Server Alias	State
<input checked="" type="checkbox"/>	1	02523	Detached			<input type="checkbox"/>	1	7816		.snom.com	-201	

[Check All / Uncheck All](#)
[Check All Extensions / Uncheck All Extensions](#)

*With selected:* [Delete Handset\(s\)](#) [Register Handset\(s\)](#) [Deregister Handset\(s\)](#) [Start SIP Registration\(s\)](#) [SIP Delete Extension\(s\)](#)

Fig. 1

## Extensions page settings

Setting	Description
Idx	Index of handsets. Handsets are numbered consecutively by the base station. With checkbox for registering handsets at and deregistering or deleting them from the base station.
IPEI	International Portable Equipment Identifier for DECT handsets which is unique worldwide. It consists of the equipment manufacturer code (EMC) and a portable serial number (PSN) issued by the manufacturer.
Handset State	Information on the respective handset's current status in the network: <b>Present@RPNxx:</b> The handset is located at the base station with RPNxx (radio fixed part number). <b>Detached:</b> The handset is turned off. <b>Located:</b> The handset is configured to locate on a specific base station, but is unable to do so (e.g., the base station is turned off). <b>Removed:</b> The handset has not been used for a specified amount of time. <b>Enabled:</b> Registration has been set up for handset, but handset has not registered yet.
Handset Type FW Info	Type of handset (e.g., M70) and firmware version (e.g., 3450.5) on the handset

Setting	Description
FWU Progress	During a firmware update, this field displays the update's progress. <b>Off:</b> No update in progress <b>Initializing:</b> Update is starting <b>x%:</b> Update in progress, x percent done <b>Verifying x%:</b> Update writing completed, FW verification ongoing <b>Waiting for charger:</b> Firmware has been transmitted to handset; update will begin when handset is placed in charger. <b>Conn. term.wait:</b> Firmware has been transmitted to repeater; update will begin when system is idle. <b>Complete:</b> Firmware on handset/repeater has been updated <b>Error:</b> Unable to update (file not found, file invalid etc.)
VoIP Idx	Index of configured SIP extensions, numbered consecutively by the base station. With checkbox for selecting the extension for SIP registration and deregistration.
Extension	The extension number that is also shown on the handset's display
Display Name	Optional. If entered, the name will be shown on the handset's display.
Server	The server selected on the <b>Add extension/Edit extension</b> page.
Server Alias	The server alias set on the <b>Servers</b> page.
State	SIP registration state. If the field is empty, the handset is not SIP-registered.

### Add/edit extension settings

These pages are used to configure new extensions and to edit existing ones, respectively. The two pages contain the same settings. **Handset** selection, **Extension** setting, and **Server** selection are mandatory. The remaining settings depend on the requirements of your PBX or VoIP provider and can be left blank, if nothing is required.

- To open the **Add extension** page, click on **Add extension** (Fig. 2).
- To open the **Edit extension** page, click on the **Extension** number (Fig. 2).

**Extensions**

[Add extension](#)

[Stop Registration](#)

	Idx	IPEI	Handset State	Handset Type FW Info	FWU Progress		VoIP Idx	Extension	Display Name	Server	Server Alias	State
<input checked="" type="checkbox"/>	1	02523	Detached			<input type="checkbox"/>	1	7816		.snom.com	-201	

[Check All / Uncheck All](#)      [Check All Extensions / Uncheck All Extensions](#)

*With selected: [Delete Handset\(s\)](#) [Register Handset\(s\)](#) [Deregister Handset\(s\)](#) [Start SIP Registration\(s\)](#) [SIP Delete Extension\(s\)](#)*

Fig. 2

**Edit extension**

Line name:

Handset:

Extension:

Authentication User Name:

Authentication Password:

Display Name:

PIN:

Mailbox Name:

Mailbox Number:

Server:

Call waiting feature:

BroadWorks Shared Call Appearance:

Broadsoft Feature Event Package:

Forwarding Unconditional Number:

Forwarding No Answer Number:   s

Forwarding on Busy Number:

**Edit extension**

Line name:

Handset:

Extension:

Authentication User Name:

Fig. 3

Settings descriptions for **Add extension** and **Edit extension** subpages:

Setting	Description
Line name	As required/desired. Specifies the line name for this extension on the handset. Used when user must select a line for outgoing calls.
Handset	Select New Handset or one of the available Handset IDXs
Extension	Extension number or SIP username, as configured in PBX or on SIP server.
Authentication User Name	As required by PBX or VoIP provider
Authentication Password	As required by PBX or VoIP provider
Display Name	As required or desired
PIN	This is the PIN for accessing the mailbox, if required by PBX or VoIP provider and if a mailbox is available. <b>Note:</b> This PIN is not to be confused with <u>either</u> the access code for registering the handset at the base station <u>or</u> the PIN for resetting the handset to factory values or for deregistering it from the base station.
Mailbox Name	If mailbox available on PBX or provided by VoIP provider. If no mailbox name is set, same as mailbox number.
Mailbox Number	If mailbox available on PBX or provided by VoIP provider. Often the same as the extension number. Accessing mailbox: Long-press key 1 on handset to connect to mailbox.
Server	Select server from drop-down menu
Call waiting feature	Turn call waiting on/off. Default: Enabled (on).
Broadsoft Feature Event Package	On/off. Applicable only to Broadsoft applications. If enabled, the extension subscribes to the Broadsoft Application Server Feature Event Package and is ready to receive SIP Notify with status for the Broadsoft server services "do not disturb (DND)" and "call forwarding" (always, busy, no answer) .

Setting	Description
Forwarding Unconditional Number	On/off. All incoming calls for this extension will be forwarded to the number entered in the text field. <b>Note:</b> This setting (both the number and the enabled/disabled status) can be changed from the handset registered to the extension. <b>Defaults:</b> Empty number field, status disabled
Forwarding No Answer Number	On/off. Incoming calls for this extension will be forwarded to the number entered in the text field if not picked up after the number of seconds entered in the adjacent field. <b>Note:</b> This setting (both the number and the enabled/disabled status) can be changed from the handset registered to the extension. <b>Defaults:</b> Empty number field, status disable
Forwarding on Busy Number	On/off. Incoming calls for this extension will be forwarded to the number entered in the text field when the line is busy. <b>Note:</b> This setting (both the number and the enabled/disabled status) can be changed from the handset registered to the extension. <b>Defaults:</b> Empty number field, status disable

## Handset settings

Click on the place holder FFFF or the IPEI to open the respective subpage (Fig 5 and 6). If you click on the IPEI of a registered handset, the handset model (Mxx) is added to the title of the page (Fig. 6).

### Extensions

AC: 0000

Save Cancel

Add extension

	Idx	IPEI	Handset State	Handset Type FW Info	FWU Progress	VoIP Idx	Extension	Display Name	Server	Server Alias	State
<input type="checkbox"/>	1	0328D 3	Present@RPN00	M70 450.5	Complete	<input type="checkbox"/>	1 80800		.snom.com		SIP Registered@RPN00
<input type="checkbox"/>	2	0328D 6				<input type="checkbox"/>	2 7771		snom.com		
<input type="checkbox"/>	3	FFFFFFFFF	Enabled			<input type="checkbox"/>	3 7772		.snom.com		

Check All / Uncheck All      Check All Extensions / Uncheck All Extensions

With selected: Delete Handset(s) Register Handset(s) Deregister Handset(s) Start SIP Registration(s) SIP Delete Extension(s)

Fig. 4

### Handset

IPEI:

Paired Terminal:

AC:

Alarm Line:

Alarm Number:

Fig. 5

### Handset (M70)

IPEI:

Paired Terminal:

AC:

Alarm Line:

Alarm Number:

Fig. 6

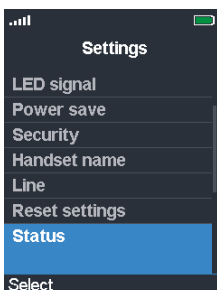

Fig. 7

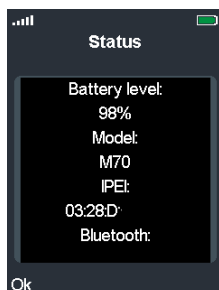





Fig. 8

Settings descriptions for **Handset** subpages:

Setting	Description
Location	In multicell installations, select from drop-down menu if more than one base-station available
IPEI	To find the IPEI, open the <b>Settings</b> menu of the handset, select <b>Status</b> (Fig. 7), and press <b>Select</b> . On the <b>Status</b> screen (Fig. 8), scroll down to the IPEI at the end of the handset status. The IPEI consists of a string of 10 decimals and capital letters. Do not enter the colons grouping the characters of the string into twos.
AC	This is the access code for registering the handset at the base station. The default is 0000 (four times zero). <b>NOTE:</b> This access code is not to be confused with <u>either</u> the PIN for resetting the handset to factory values or for deregistering it from the base station (default also 0000) <u>or</u> the PIN for accessing the mailbox.
Alarm Line	This is the extension number the handset is registered for (not available on M25.)
Alarm Number	This is the phone number the handset will call when the emergency alarm button is pressed. (not available on M25.)
<b>Alarm Profiles</b> (alarm button configurable for M65, M70, M80, M85, and M90; not available on M25). For more information, see "Emergency alarm" on page 31 and "Alarm" on page 73.	
Profile	If an alarm profile has been configured on the <b>Alarm</b> page and a profile alias was assigned, it will be shown in parentheses following the number of the profile (i.e, Profile 0 (Shop)). Click on the checkbox of a profile to select.
Alarm Type	If an alarm profile has been configured on the <b>Alarm</b> page, this item will say <b>Alarm Button</b> .
<b>Import Local Phonebook</b>	
<p>These are the individual contacts <b>stored on your handset only</b> and accessible via the  symbol on the handset's display.</p> <p><b>Note:</b> Not to be confused with the central directory downloaded onto the base station on the <b>Central Directory</b> page and accessible to all handsets registered at the base station by pressing the  symbol (see "Local central directory" on page 32).</p> <p>Click on <b>Browse</b> and select the file from the directory of your PC, then click on <b>Load</b>. The file must adhere to the same formats as those for the local central directory (see "Preparing the phone directory file" on page 32).</p>	
<b>Export Local Phonebook</b>	
<p>These are the individual contacts on your handset, accessible via the  symbol on the handset's display. The file is exported to your PC as a comma-separated values (csv) file.</p>	

# Servers

On this page you add and remove SIP/NAT servers, select the server the base station should connect to, and change the default settings.

**Servers**

**Server 1:**  
 .snom.com

**Server 3:**  
 10.110.25 -

[Add Server](#)  
[Remove Server](#)

**Server 1:**

Server Alias:

NAT Adaption:

Registrar:

Outbound Proxy:

Conference Server:

Call Log Server:

Reregistration time (s):

SIP Session Timers:

Session Timer Value (s):

Use SIP as XSI Authentication:

SIP Transport:

Signal TCP Source Port:

Use One TCP Connection per SIP Extension:

RTP from own base station:

Keep Alive:

Show Extension on Handset Idle Screen:

Hold Behaviour:

Remote Ring Tone Control:

Attended Transfer Behaviour:

Use Own Codec Priority:

DTMF Signalling:

DTMF Payload Type:

Remote Caller ID Source Priority:

Enable Blind Transfer:

XSI User Services:

Codec Priority:

RTP Packet Size:

Secure RTP:

Secure RTP Auth:

SRTP Crypto Suites:

Fig. 1

Settings descriptions:

Setting	Description
Server Alias	Server alias. <b>Default:</b> empty.
NAT Adaption	<b>Default:</b> Disabled. Ensures that all SIP messages go directly to the NAT gateway. <b>Please note:</b> <b>Enabled:</b> When the base station receives a SIP response to a REGISTER request with a "Via" header that includes the "received" parameter (e.g.: <i>Via: SIP/2.0/UDP 10.1.1.1:4540;received=68.44.20.1</i> ), it will adapt its contact information to the IP address from the "received" parameter. The base station will then send another REGISTER request with the updated contact information. <b>Disabled:</b> The base station will ignore the "received" parameter.
Registrar	SIP server proxy DNS or IP address. Specifying the port number is optional.



Setting	Description
Outbound proxy	Session border controller DNS or IP address. Alternatively SIP server outbound proxy address. Set the outbound proxy to the address and port of the private NAT gateway so that SIP messages are sent via this gateway. Format: addr:port <b>Default value:</b> Blank
Conference server	For Broadsoft conference server only: If the IP address of the server is set in this text field, pressing the handset's conference function key during a call will establish a connection to the conference server. If the field is empty, the system's 3-party local conference is used.
Call log server	Broadsoft call log feature. If the IP address of the server is set in this text field, pressing the handset's call log/call history key during a call will establish a connection to the call log server.
Reregistration time (s)	The "expires" value signaled in SIP REGISTER requests. This value indicates how long the current SIP registration is valid, and hence it specifies the maximum time between SIP registrations for the SIP account. Permitted value(s): Maximum 65636 seconds. A value below 60 seconds is not recommended.
SIP Session Timers	RFC 4028. A "keep-alive" mechanism for calls. The session timer value specifies the maximum time between "keep-alive" or more correctly session refresh signals. If no session refresh is received when the timer expires, the call will be terminated. <b>Default:</b> Enabled.
Session timer value (s)	Default value: 1800 seconds. Permitted values: Minimum 90 sec, maximum 65636 sec. If the setting is disabled, session timers will not be used.
Use SIP as XSI authentication	TBA
SIP Transport	Default: UDP. Other options: TCP, TLS 1.0
Signal TCP Source Port	When SIP Transport is set to TCP or TLS, respectively, a TCP or TLS connection will be established for each SIP extension. The source port of the connection will be chosen by the TCP stack, and the local SIP port parameter specified in the SIP/RTP settings will not be used. The "Signal TCP Source Port" parameter specifies whether the used source port shall be signaled explicitly in the SIP messages. <b>Default:</b> Enabled.
Use one TCP connection per SIP extension	When using TCP or TLS as SIP transport, choose whether the base station is to establish one TCL or TLS connection for <b>each</b> SIP extension or one TCL or TCS connection that <b>all</b> SIP extensions will use. <b>Note:</b> If TLS is used and the SIP server requires client authentication (i.e., requests a client certificate), this setting must be disabled. Settings: Disabled (one TCL or TLS connection for <b>all</b> SIP extensions); Enabled (one TCL or TLS connection for <b>each</b> SIP extension) <b>Default:</b> Disabled
RTP from own base station	If disabled, the RTP stream will be sent from the base station where the handset is located. If enabled, the RTP stream will always be sent from the base station where the handset is registered. <b>Default:</b> Enabled
Keepalive	<b>Default:</b> Enabled. When enabled, a new keepalive message will be sent out to the Registrar/Proxy port after 30 seconds in order to have the port stay open and the phone remain reachable.
Show extension on handset idle screen	Default: Enabled. When enabled, the extension number is displayed on the idle screen of the handset.

Setting	Description
Hold behavior	<p>Specifies the behaviour of the handset hold feature. The options are:</p> <p>RFC 3264: Hold is signaled according to RFC 3264, i.e. the connection information part of the SDP contains the IP address of the endpoint, and the direction attribute is for <i>sendonly</i>, <i>recvonly</i> or <i>inactive</i> streams, depending on the context.</p> <p>RFC 2543: The "old" way of signaling HOLD. The connection information part of the SDP is set to 0.0.0.0, and the direction attribute is <i>sendonly</i>, <i>recvonly</i> or <i>inactive</i>, depending on the context.</p> <p><b>Default value:</b> RFC 3264.</p>
Remote ringtone control	<p>Enables the server to control which ringtone is used on the handsets. Also known as "distinctive ring" and brand names used by various PBXs.</p> <p><b>Default:</b> Disabled</p>
Attended transfer behavior	<p>Depending on whether the PBX requires the second call to be active (i.e., not on hold) before the REFER is sent, this setting defines whether pressing the "Transfer" function key on a handset will put the second call on hold.</p> <p>Setting "Hold 2nd Call": Pressing the transfer key puts the second call on hold before REFER is sent.</p> <p>Setting "Do Not Hold 2nd Call": Pressing the transfer key results in sending of REFER without first putting the second call on hold.</p> <p><b>Default:</b> Hold 2nd Call</p>
Use own codec priority	<p>This setting specifies whether the incoming call's codec priority (setting: disabled) or the system's own codec priority (setting: enabled) will be used for the call.</p> <p><b>Default:</b> Disabled</p>
DTMF signaling	<p>This setting specifies how the decimal digits (and '*' and '#') are converted into sounds that share similar characteristics with voice to easily traverse networks designed for voice.</p> <p>SIP INFO: Carries application-level data along SIP signalling path (for example: DTMF digits generated during SIP session <b>or</b> DTMF tones via data packets in the same internet layer as the voice stream, etc.).</p> <p>RFC 2833: DTMF handling for gateways, end systems, and RTP trunks (e.g.: Sending DTMF tones via data packets in different internet layer as the voice stream).</p> <p>Both: Enables SIP INFO and RFC 2833 modes.</p> <p><b>Default:</b> RFC 2833</p>
DTMF payload type	<p>This setting allows the user to specify a value for the DTMF payload type / telephone event (RFC2833).</p> <p><b>Default value:</b> 101</p>
Remote Caller ID Source Priority	<p>SIP information field used for Caller ID source. Options:</p> <p>PAI - FROM FROM ALERT_INFO - PAI - FROM</p>
Enable blind transfer	<p>This setting specifies whether blind transfer of calls is allowed (enabled) or not.</p> <p><b>Default:</b> Enabled</p>
XSI user services	

Setting	Description
Codec priority	<p>This setting specifies the codec priority for audio compression and transmission. After changing the order of priority with the <b>Up/Down</b> buttons, click on <b>Reset codes</b>.</p> <p><b>NOTE:</b> In a multicell setup, you must also go to the multicell page and click on <b>Reboot chain</b> in order to update the handsets in the multicell installation.</p> <p><b>Options:</b> G.722; G.711A-law, <math>\mu</math>-law; G.726</p> <p><b>NOTE:</b></p> <p>With G.722 in the list, the codec negotiation algorithm is active. This causes the handset setup time to be slightly slower than when G.722 is removed from the list.</p> <p>With G.722 as first priority, the number of simultaneous calls per base station will be reduced from 10 (8) to 4 calls.</p>
RTP packet size	<p>This setting specifies the packet size offered as preferred RTP packet size during RTP packet size negotiation.</p> <p><b>Default value:</b> 20 ms</p>
Secure RTP	<p>If enabled, RTP will be encrypted (AES-128) using the key negotiated via the SDP protocol at call setup.</p> <p><b>Default:</b> Disabled.</p>
Secure RTP Auth	<p>If enabled, secure RTP will use authentication of the RTP packages.</p> <p><b>NOTE:</b> With enabled SRTP authentication, a maximum of 4 concurrent calls per base station is possible in both single-cell and multicell systems.</p> <p><b>Default:</b> Disabled.</p>
SRTP Crypto Suites	Supported SRTP Crypto Suite: AES_CM_128_HMA_SHA1_32

# Network

## Network Settings

### IP settings

DHCP/Static IP:

IP Address:

Subnet Mask:

Default Gateway:

DNS (Primary):

DNS (Secondary):

MDNS:

### VLAN Settings

ID:

User Priority:

Synchronization:

Send LLDP-MED message:

Try obtaining VLAN via LLDP-MED:

### DHCP Options

Plug-n-Play:

### TCP Options

TCP Keep Alive Interval:

### NAT Settings

Enable STUN:

STUN Server:

STUN Bindtime Determine:

STUN Bindtime Guard:

Enable RPORT:

Keep alive time:

### SIP/RTP Settings

Use Different SIP Ports:

RTP Collision Detection:

Always reboot on check-sync:

Outbound Proxy Mode:

Failover SIP Timer B:

Failover SIP Timer F:

Local SIP port:

SIP ToS/QoS:

RTP port:

RTP port range:

RTP ToS/QoS:

SIP registration mode:

Setting	Description
<b>IP settings</b>	
DHCP/Static IP	Allowing changes in protocol for getting a dynamic IP address. When DHCP is enabled, the other IP settings and options are not available. DHCP enabled: IP addresses are allocated from a pool of available addresses. Static IP: IP addresses are manually assigned by the network administrator. <b>Default:</b> DHCP.
IP address	Enter when using static IP address. Not accessible when using DHCP.
Subnet mask	Enter when using static IP address. Not accessible when using DHCP.
Default gateway	Enter IP address of your router when using static IP address. Not accessible when using DHCP.
DNS (Primary)	Enter DNS server address of Internet service provider when using static IP address. Not accessible when using DHCP.
DNS (Secondary)	
MDNS	Default: Disabled. Enable to allow Multicast Domain Name system (MDNS).
<b>VLAN Settings</b>	The VLAN settings can be used on a managed network with separate Virtual LANs (VLAN) for sending voice and data traffic. To work on these networks, the base station can tag voice traffic it generates on a specific "voice VLAN" using the IEEE 802.1q specification.

Setting	Description
ID	12-bit identification of the 802.1Q VLAN. Permitted value(s): Decimals 0 to 4094. A VLAN ID of 0 is used to identify priority frames and the ID of 4095 (i.e., FFF) is reserved. If 0 is set, there is no VLAN tagging or VLAN discovery through DHCP. <b>Default:</b> 0.
User priority	3-bit value defining user priority. Values are 0 (best effort) and 1 to 7 (lowest to highest priority). The values can be used to prioritize different classes of traffic (voice, video, data, etc.). <b>Default:</b> 0
Synchronization	If enabled, the VLAN ID is automatically synchronized between the base stations in a multicell chain. They will be automatically rebooted during the synchronization. <b>Default:</b> Disabled.
Send LLDP-MED message	TBA <b>Default:</b> Disabled.
Try obtaining VLAN via LLDP-MED	TBA <b>Default:</b> Disabled.
<b>DHCP Options</b>	
Plug-n-play	If enabled: DHCP option 66 is used to automatically provide PBX IP address to base station. <b>Default:</b> Disabled.
<b>TCP Options</b>	
TCP keep alive interval	Default: 120s. The time (in seconds) between individual keepalive probes.
<b>NAT Settings</b>	
Enable STUN	<b>Default:</b> Disabled. Enable to use STUN.
STUN server	Permitted value(s): IPv4 values or URL. Currently only IPv4 is supported.
STUN bindtime determine	<b>Default:</b> Disabled.
STUN bindtime guard	Time in seconds. Permitted values: Positive integers. <b>Default:</b> 80.
Enable RPORT	<b>Default:</b> Disabled. Enable to use RPORT in SIP messages.
Keep alive time	The interval in seconds at which the base station sends a keepalive signal to the SIP server to maintain NAT bindings. Permitted values: Positive integers. <b>Default:</b> 90.
<b>SIP/RTP Settings</b>	
Use different SIP ports	If disabled, the local SIP port parameter specifies the source port used for SIP signaling in the system. If enabled, the local SIP port parameter specifies the source port used for first user agent (UA) instance. Succeeding UAs will get succeeding ports. <b>Default:</b> Disabled.
RTP collision detection	Enabled: If two sources have the same SSRC identifier, the second RTP is discarded. Disabled: SSRC identifiers are not checked; device accepts all sources. <b>Default:</b> Enabled.
Always reboot on checksync	Enable to reboot base station whenever new configuration is loaded. <b>Default:</b> Disabled.
Outbound proxy mode	Use Always: All outbound calls are sent to outbound proxy. Only Initial request: Use outbound proxy for initial SIP requests only. <b>Default:</b> Use Always
Failover SIP timer B	TBA
Failover SIP timer F	TBA

Setting	Description
Local SIP port	The source port used for SIP signaling. <b>Permitted values:</b> Port number default 5060.
SIP ToS/Qos	Priority of call control signaling traffic based on both IP layers of Type of Service (ToS) byte. ToS is referred to as Quality of Service (QoS) in packet-based networks. <b>Permitted values:</b> Positive integer, default is 0x68.
RTP port	The first RTP port to use for RTP streaming. <b>Permitted values:</b> Port number default 50004 (depending on the setup).
RTP port range	The number of ports that can be used for RTP audio streaming. <b>Permitted values:</b> Positive integer, default is 40.
RTP TOS/QoS	Priority of RTP traffic based on the IP layer ToS byte. ToS is referred to as Quality of Service (QoS) in packet-based networks. See RFC 1349 for details. The "cost" bit is not supported. <ul style="list-style-type: none"> <li>• Bit 7..5 defines precedence</li> <li>• Bit 4..2 defines Type of Service (ToS)</li> <li>• Bit 1..0 are ignored</li> </ul> <b>Permitted values:</b> Port number default 5060.
SIP registration mode	

# Management

## Management Settings

Base Station Name:

### Settings

HTTP Management username:

HTTP Management password:

Factory reset from button:

Enable Automatic Prefix:

Set Maximum Digits of Internal Numbers:

Set Prefix for Outgoing Calls:

### Configuration

Configuration Server Address:

Filename:

### Text Messaging

Text Messaging:

Text Messaging & Alarm Server:

Text Messaging Port:

Text Messaging Keep Alive (m):

Text Messaging Response (s):

Text Messaging TTL:

### Terminal

Keep Alive (m):

Auto Stop Alarm:

Auto Stop Alarm Delay (s):

### Syslog/SIP Log

Upload of SIP Log:

Syslog Level:

TLS security:

Syslog Server IP Address:

Syslog Server Port:

### License

Idx	Description
No Entries	

License Key:

This page allows the administrator to configure base stations to perform specific functions such as file transfers, firmware up/downgrades, password management, and SIP/debug logs.

Setting	Description
Base station name	The name of the base station that appears at the top of its web interface and as its name within the base station group and the DECT chain of a multicell installation. <b>Default:</b> The model, i.e., M900. If you employ more than base station, it is advisable to give them distinct names, e.g., M900-01, M900-02, M900-reception, or another distinguisher. <b>Maximum number of characters:</b> 35
<b>Settings</b>	
HTTP management username	Permitted value: 8-bit string
HTTP management password	Password for access to the configuration server. HTTP client credentials are formed by HTTP management username and this password. Permitted value: 8-bit string
Factory reset from button	The factory reset through pressing of the reset button on M900 casing for 10 seconds can be deactivated here. <b>Default:</b> Activated

Setting	Description
Enable automatic prefix	<p><i>Disabled:</i> No automatic prefix added.</p> <p><i>Enabled:</i> The base station adds the leading digit defined in <b>Set prefix for outgoing calls</b>.</p> <p><i>Enabled+fallthrough on * and #:</i> Enables detection of * or # at the first digit of a dialed number. In case of detection, the base station will not add the leading digit defined in <b>Set prefix for outgoing calls</b> to the dialed number.</p> <p>Examples, leading digit is defined as 0:</p> <ul style="list-style-type: none"> <li>1: number dialed on handset <b>*1234</b> -&gt; number sent to pbx <b>*1234</b></li> <li>2: number dialed on handset <b>#1234</b> -&gt; number sent to pbx <b>#1234</b></li> <li>3: number dialed on handset <b>1234</b> -&gt; number sent to pbx <b>01234</b></li> </ul> <p><b>Default:</b> Disabled.</p>
Set maximum digits of internal numbers	<p>This setting is used to detect internal numbers. No prefix number will be added to a dialed internal number.</p> <p><b>Default:</b> 0.</p>
Set prefix for outgoing calls	<p>Prefix number for the enabled automatic prefix feature.</p> <p><b>Permitted values:</b> 1 to 9999.</p> <p><b>Default:</b> Empty.</p>
<b>Configuration</b>	
Configuration server address	<p>DNS or IP address of server providing configuration file to base station.</p> <p><b>Default:</b> Empty. Permitted values: IP address or URL.</p>
Filename	<b>Default:</b> Empty.
<b>Text messaging</b>	
Text messaging	<p><i>Disable/enable</i> messaging via server, if provided by third-party service.</p> <p><i>Enable without server:</i> Allow handsets to send messages to other handsets supporting messaging.</p> <p><b>Default:</b> Disabled.</p>
Text messaging & alarm server	<p>Permitted values: IP address or URL.</p> <p><b>Default:</b> Empty.</p>
Text messaging port	<p>Port number of message server.</p> <p><b>Default:</b> 1300.</p>
Text messaging keepalive (m)	<p>Intervals in minutes between keepalive messages. Permitted values: Positive integers.</p> <p><b>Default:</b> 30.</p>
Text messaging response (s)	<p>Frequency in seconds of response timeouts.</p> <p><b>Permitted values:</b> Positive integers.</p> <p><b>Default:</b> 30.</p>
Text messaging TTL	<p>Text messaging time to live <b>in seconds</b>.</p> <p><b>Permitted values:</b> Positive integers.</p> <p><b>Default:</b> 0.</p>
<b>Terminal</b>	
Keep Alive (m):	<p>If other than 0, the handset sends an (emergencyLocationMsg) containing the RSSI measurements with the interval in minutes specified in this setting.</p> <p><b>Permitted values:</b> Positive integer.</p> <p><b>Default:</b> 0</p>
Auto Stop Alarm:	<p>Needs to be enabled to be able to use <b>Auto stop alarm Delay</b></p> <p><b>Default:</b> Disabled.</p>
Auto Stop Alarm Delay (s)	<p>Handsets automatically stop alarm announcement (emergencySms) after the number of seconds specified in this setting.</p> <p><b>Default:</b> 30.</p>



Setting	Description
<b>Syslog/SIP Log</b>	
Upload of SIP log	When enabled, low-level SIP debug messages will be saved to the server in the following file format: <MAC_address><Time_Stamp>SIP.log <b>Default:</b> Disabled.
SIP log server address	Permitted values: IP address or URL. <b>Default:</b> Empty.
Syslog level	<i>Off:</i> No data is saved on syslog server <i>Normal operation:</i> Normal operation events (incoming and outgoing calls, handset registration, DECT location, call lost due to busy) as well as critical system errors and general system information are logged. <i>System analyze:</i> Handset roaming and handset firmware updates status in addition to the normal operation messages. <i>Debug:</i> Used by Snom for debug. Should not be enabled during normal operation. <b>Default:</b> Normal operation.
Syslog server IP address	Permitted values: IP address or URL. <b>Default:</b> 0.
Syslog server port	Port number of syslog server. <b>Default:</b> 514.
<b>License</b>	Not necessary. <b>Setting:</b> empty.

## Firmware update

### Firmware Update Settings

Firmware update server address:

Firmware path:

Terminal file path:

Type	Required version	Required branch	Voice prompts
Update Base Stations	<input type="text" value="450"/>	<input type="text" value="5"/>	
M70	<input type="text" value="450"/>	<input type="text" value="5"/>	
M80	<input type="text" value="450"/>	<input type="text" value="5"/>	
M90	<input type="text" value="450"/>	<input type="text" value="5"/>	
8930g	<input type="text" value="0"/>	<input type="text" value="0"/>	<input type="text"/>
M5	<input type="text" value="0"/>	<input type="text" value="0"/>	

Setting	Description
Firmware update server address	IP address or DNS of update source <b>Valid inputs:</b> URL or IP address. <b>Note:</b> Cannot end with slash / character. <b>Examples:</b> http://dect.snom.com, 10.10.104.41 <b>Default:</b> empty.
Firmware path	If required, location of firmware on server or firmware update server path where firmware update files are located. <b>Note:</b> Must begin with slash / character. <b>Example:</b> /M700_v0450.fwu <b>Default:</b> empty.
Terminal file path	Not applicable. <b>Setting:</b> empty
Type	All types of handsets and repeaters (i.e., M65, M85, M25, M5) that have been registered at the base station, even when all devices of any type are turned off.
Required version (base station, handset, repeater, headset)	Version of firmware the type of device is to be upgraded to. <b>Note:</b> Value 0 will disable firmware upgrade. <b>Valid input:</b> 8-bit string <b>Example:</b> 450 <b>Default:</b> 0.
Required branch (base station, handset, repeater)	Branch of firmware the type of device is to be upgraded to. <b>Valid input:</b> 8-bit string <b>Example:</b> 5 <b>Default:</b> empty.
Voice prompts	For headsets only: Name of the voice prompt file

## Country/time settings

### Country/Time Settings

Select country:

State / Region:

Notes:

Select Language:

Time Server:

Allow broadcast NTP:

Refresh time (h):

Set timezone by country/region:

Timezone:

Set DST by country/region:

Daylight Saving Time (DST):

DST Fixed By Day:

DST Start Month:

DST Start Date:

DST Start Time:

DST Start Day of Week:

DST Start Day of Week Last in Month:

DST Stop Month:

DST Stop Date:

DST Stop Time:

DST Stop Day of Week:

DST Stop Day of Week Last in Month:

Fig. 1

### js

Select country:

State / Region:

Notes:

Select Language:

Time Server:

Allow broadcast NTP:

Refresh time (h):

Set timezone by country/region:

Timezone:

Set DST by country/region:

Daylight Saving Time (DST):

DST Fixed By Day:

DST Start Month:

DST Start Date:

DST Start Time:

DST Start Day of Week:

DST Start Day of Week Last in Month:

DST Stop Month:

DST Stop Date:

DST Stop Time:

DST Stop Day of Week:

DST Stop Day of Week Last in Month:

Fig. 2

## Country/region, language, and automatic time and DST settings

The **Country/time settings** page contains drop-down menus for the selection of your country, a state or region within that country, if applicable, and the language to be used on the web interface of the base station.

In the default setting, the time zone and daylight saving time (DST) are set automatically so that the time and DST of the selected country and, if applicable, the selected region of the country will be used on the base station and the handsets. The automatic settings (Fig. 1) can be disabled by unchecking the checkboxes for the settings **Set timezone by country/region** and **Set DST by country/region**; the manual settings are enabled simultaneously (Fig. 2).

Setting	Description
Select country	The country setting controls the inband tones used by the base station (dial tone, ringing tone (colloquially called ringback tone, Freiton), busy, call waiting, redial tones). Select a country from the drop-down menu.
State/region	This drop-down menu is available when the selected country has more than one timezone. Select a state or region from the drop-down menu.

Setting	Description
Notes	Applicable to some locations in US and Brazil. When counties, towns etc. are using different time settings than the timezone they are located in, a text field will open with description of the exception when you select the timezone. The text field is not visible when locations without these exceptions are selected.
Select language	The language used on the web interface of the base station can be set independently from the country setting. Select a language from the drop-down menu. <b>Default:</b> English
Set timezone by country/region	When checked, the timezone of the selected country/region will be used. When unchecked, the time zone (UTC +/- n) and daylight saving time settings can be selected manually from the drop-down menus of the individual settings. <b>Default:</b> Checked.
Set DST by country/region	When checked, the DST of the selected country/region will be used. When unchecked, the daylight saving time settings can be selected manually from the drop-down menus of the individual settings. <b>Default:</b> Checked.

## Time server

The time server is mandatory for multicell configurations where it supplies the time used for data synchronisation. The time server is also used in the debug logs, for SIP trace information pages, and to determine when to check for new configuration and firmware files.

**Note: Multicell systems will not work without a configured time server.**

When time server parameters are changed, the system must be rebooted. Click on the **Save and Reboot** button. It can take up to 15 minutes before all base stations are synchronized, depending on the number of base stations in the system.

For stand-alone base stations, setting the time server is optional.

Setting	Description
Time server	IP address or DNS name of NTP server <b>Valid inputs:</b> URL or IP address (IPv4 only). <b>Default:</b> empty.
Allow broadcast NTP	Check to use time server. <b>Default:</b> Checked
Refresh time (h)	Time interval in hours within which the time server refreshes. <b>Valid inputs:</b> Positive integers

## Manual time and DST settings

The manual settings are enabled when the checkboxes for the settings **Set timezone by country/region** and **Set DST by country/region** are unchecked (Fig. 2).

Setting	Description
Timezone	Select timezone (UTC +/- n) from the drop-down menu. <b>Default:</b> Checked
Daylight saving time (DST)	Select disabled, enabled, or automatic from drop-down menu. <b>Enabled:</b> DST starts/ends immediately, none of the following settings are available. <b>Disabled:</b> None of the following settings are available, DST will not be used. <b>Automatic:</b> DST will start and stop automatically on the specified dates. <b>Default:</b> Automatic
DST fixed by day	<b>Use month and date:</b> If you want to enter a calendar date. When selected, the text fields of "DST start date", "DST start time", "DST stop date", and "DST stop time" are available. <b>Use month and day of week:</b> If you want to select a day of the week, i.e., Sunday. When selected, the drop-down menus of "DST start day of week", "DST start day of week last in month", "DST start time", "DST stop day of week", "DST stop day of week last in month", and "DST stop time" are available.
DST start month	Select month from drop-down menu. <b>Default:</b> March
DST start date	If "DST fixed by day" is set to "Use month and date", enter calendar in text field. <b>Valid inputs:</b> Positive integers 1-31. <b>Default:</b> 0
DST start time	Enter start time in text field. <b>Valid inputs:</b> Positive integers 0 - 23. <b>Default:</b> 2
DST start day of week	If "DST fixed by day" is set to "Use month and day of week", select the day of the week from the drop-down menu. <b>Default:</b> Sunday
DST start day of week last in month	If "DST fixed by day" is set to "Use month and day of week", select the week of the month from the drop-down menu. <b>Options:</b> First, last, second, second last, third (e.g. Sunday) in month <b>Default:</b> Last in month, i.e., last week in month.
DST stop month	Select month from drop-down menu. <b>Default:</b> October
DST stop date	If "DST fixed by day" is set to "Use month and date", enter calendar day in text field. <b>Valid inputs:</b> Positive integers 1-31. <b>Default:</b> 0
DST stop time	Enter stop time in text field. <b>Valid inputs:</b> Positive integers 0 - 23. <b>Default:</b> 2
DST stop day of week	If "DST fixed by day" is set to "Use month and day of week", select the day of the week from the drop-down menu. <b>Default:</b> Sunday
DST stop day of week last in month	If "DST fixed by day" is set to "Use month and day of week", select the week of the month from the drop-down menu. <b>Options:</b> First, last, second, second last, third (e.g. Sunday) in month <b>Default:</b> Last in month, i.e., last week in month.

# Security

## Security Device Identity

Idx	Issued To	Issued By	Valid Until
-----	-----------	-----------	-------------

No certificates installed:

### Import Device Certificate and Key Pair:

Filename:  No files selected.

## Trusted Server Certificates

Idx	Issued To	Issued By	Valid Until
-----	-----------	-----------	-------------

No certificates installed:

### Import Trusted Certificates:

Filename:  No file selected.

## Trusted Root Certificates

Idx	Issued To	Issued By	Valid Until
-----	-----------	-----------	-------------

No certificates installed:

### Import Root Certificate:

Filename:  No file selected.

Use Only Trusted Certificates:   Disabled

## Password:

Username:   
 Current Password:   
 New Password:   
 Confirm Password:

## Secure Web Server:

HTTPS:   Disabled

On this page, you can download certificates, change the password required for logging onto the web interface, and select whether to use the embedded secure web server (HTTPS).

**Note:** SIP and RTP security are server-dependent.

Setting	Description
Idx	Index number. <b>Default:</b> Fixed indexes.
Issued to	IP address or organization/company. This is part of the certificate file. <b>Default:</b> Empty
Issued by	IP address or organization/company. This is part of the certificate file. <b>Default:</b> Empty
Valid until	Date Time Year. This is also part of the certificate file. <b>Default:</b> Empty
Use only trusted certificates	Select "enabled" from the drop-down menu to allow use of trusted certificates only. <b>Default:</b> Disabled.

1. Click on **Browse** and select the file from your PC or server. The name of the selected file is shown to the right of the Browse button.
2. Click on **Load**. The certificate is added to the list of certificates.



## Device identity

This is the certificate and personal key used by the base when acting as a server or when the server requires client authentication in the SSL handshake procedure. The supported format is DER-encoded binary X.509 (.cer), and the key must be provided as an unencrypted PKCS#8 binary file (.key).

**Note:** Certificate and key pair must be loaded at the same time.

The supported format is DER-encoded binary X.509 file (.cer), and the key must be provided as an unencrypted PKCS#8 binary file (.key).

1. Click on **Browse** and select both files from your PC or server.

Name	Date Modified	Size	Kind
 certificate-key-DER-PKCS8.key	Today 19:28	634 bytes	Keyn
 certificate-DER.cer	Today 19:23	1 KB	certif

The names of the selected files are shown to the right of the **Browse** button.

2. Click on **Load**. Certificate and key pair are added to the list of certificates.

Idx	Issued To	Issued By	Valid Until
<input type="checkbox"/> 0	snomcert	examplecom	13/12 18:1:6 2025
<input type="checkbox"/> 1			

## Trusted server certificates

Intermediate certificates (non-root certificates) trusted by the base station. Used to validate a received certificate chain (or a chain of trust) in scenarios where only the root certificate is sent by the server during the SSL handshake procedure.

## Trusted root certificates

Root certificates (self-signed) trusted by the base station. Used to validate received root certificates sent by the server during the SSL handshake procedure.

By enabling **Use Only Trusted Certificates** only valid certificates received from the server will be loaded into the system. If no valid matching certificate is found during the establishment of the TLS connection, the connection will fail. When **Use Only Trusted Certificates** is disabled, all certificates received from the server will be accepted.

**Note:** It is important to use correct date and time of the system when using trusted certificates. In case of undefined time/date, the certificate validation can fail.

## Password

Valid characters for username and password are:

- letters a–z and A–Z
- numerals 0–9, and the
- special characters @/|<>\_-.!\*+##

Setting	Description
Username	Up to 15 valid characters. <b>Default:</b> admin
Current password	Any valid characters. <b>Default:</b> admin
New password	Up to 15 valid characters. <b>Default:</b> Empty
Confirm password	Repeating new password to avoid typing errors

## Secure web server

Setting	Description
HTTPS	Select the embedded secure HTTPS server from the drop-down menu and click on <b>Save</b> . <b>Default:</b> Disabled



## Central directory

The central directory is accessible from all handsets registered at the same base station or in the same multicell installation. The central directory can be a phone list downloaded to the base station or an external source like the company LDAP register.

**Note:** You can use only one or the other, not both simultaneously.

See "Local central directory" on page 32 for information on how to prepare files and how to download them onto the base station. See "LDAP" on page 36 for an LDAP example.

Setting	Description
Location	Select <b>Local</b> or <b>LDAP Server</b> from the drop-down menu. <b>Default:</b> Local
If setting is <b>Central Directory</b> (local setting selected):	
Location	Setting <b>Local</b> is selected.
<b>Note:</b> The parameters <i>Server</i> , <i>Filename</i> , and <i>Phonebook reload interval</i> are used only if the directory file is located on a server. Enter the data and click on <b>Save</b> .	
Server	Enter the IP address and path to the file of the phone list to be downloaded. <b>Default:</b> Empty
Filename	Enter the file name of the phone list to be downloaded. <b>Default:</b> Empty
Phonebook reload interval (s)	Enter the reload interval in seconds. To avoid overloading the base station, we recommend to set longer intervals or to turn off automatic reloading. <b>Default:</b> 0 (phone list will not be reloaded automatically)
If setting is <b>LDAP Central Directory</b> :	
Central directory location	Setting <b>LDAP server</b> is selected.
Server	IP address or URL of the LDAP server
TLS security	When this setting is <b>enabled</b> the system uses encrypted TCP; when it is disabled it uses UDP.
Port	Server port for LDAP
Sbase	This setting specifies the LDAP search base (the distinguished name of the search base object) which corresponds to the location in the directory from which the LDAP search is requested to begin. The criteria depend on the configuration of the LDAP server.
LDAP filter	LDAP name filter is the search criteria for name look-ups. The format of the search filter is compliant to the standard string representations of LDAP search filters (RFC 2254). <b>Default:</b> Empty.
Bind	Specifies the bind "username" for LDAP servers when the handset connects to the server. If the server allows anonymous binds, you can leave the setting blank.
Password	Specifies the bind "password" for LDAP servers. If the server allows anonymous binds, you can leave the setting blank.
Virtual List	If your LDAP server does not support server-side result pagination and sorting (VLV extension), select "disabled" from the drop-down list. <b>Default:</b> Enabled.

<b>Setting</b>	<b>Description</b>
SIP extension part of user login	TBA
Handset identity settings	
Name	Select <b>cn</b> or <b>sn+given name</b> from drop-down menu. <b>Default:</b> cn
Work	Enter an LDAP number attribute <b>Preset:</b> telephoneNumber
Home	Enter an LDAP number attribute <b>Preset:</b> homophone
Mobile	Enter an LDAP number attribute <b>Preset:</b> mobile

# Multicell

Please note that all base stations in a multicell setup must have the same firmware. We recommend that you update all base stations to the latest firmware and reset them before beginning the multicell installation.

- Reset secondary base stations to defaults, and, after the reset, change their **DHCP Options** "Plug-n-Play" setting on the **Network** page to "Disabled".
- Use only the designated primary (master) base station to enter all data, i.e., set up the SIP server(s), creating extensions/user accounts, register handsets, etc.
- **Note:** Entering a time server on the **Time** settings page of the primary base station's web interface is mandatory for multicell installations!

For further information on multicell installation, see the "M900 Multicell Deployment Guide" at <https://service.snom.com/>.

## Multi cell Settings

### Multi Cell Status

System Information:	Keep Alive
Last packet received from IP:	10.110. . . 06-Feb-2020 10:49:20
Sync Data from IP:	10.110. . .

### Settings for this unit

These settings are used to connect this unit to a system.

Multi cell system:	<input type="text" value="Enabled"/>
System chain ID:	<input type="text" value="9001"/>
Synchronization time (s):	<input type="text" value="60"/>
Data Sync:	<input type="text" value="Multicast"/>
Primary Data Sync IP:	
Multi cell debug:	<input type="text" value="None"/>

### DECT system settings

These settings are DECT settings for the system.

RFPI System:	1346 ; RPN:04
Auto configure DECT sync source tree:	<input type="text" value="Enabled"/>
Allow multi primary:	<input type="text" value="Disabled"/>
Auto create multi primary:	<input type="text" value="Disabled"/>

### Base station settings

Number of SIP accounts before distributed load:	<input type="text" value="4"/>
SIP Server support for multiple registrations per account:	<input type="text" value="Disabled"/> (used for roaming signalling)
System combination (Number of base stations/Repeaters per base station):	<input type="text" value="254/0"/>

<input type="button" value="Save and Reboot"/>	<input type="button" value="Save"/>	<input type="button" value="Cancel"/>
--	-------------------------------------	---------------------------------------

Fig. 1

**Base Station Group**

DECT sync source recovery: [Restore saved tree](#) / [Save current tree](#)

	ID	RPN	Version	MAC Address		IP Address	IP Status	DECT sync source	DECT property	Teee1588 state	Base Station Name
<input type="checkbox"/>	0	00	450.13	000413	3	10.110. . . .	Connected	Select as primary	Primary	LAN:Primary	Kitchen-6-M900
<input checked="" type="checkbox"/>	1	01	450.13	000413E	5	10.110. . . .	Connected	Primary:RPN00 (-cod8m)	Locked	LAN:ID:0	Printer-6-M900
<input checked="" type="checkbox"/>	2	02	0	000413B	1	0.0.0.0	Connection lost!	(any) RPN		DECT:RPN:any	
<input checked="" type="checkbox"/>	3	03	450.13	000413B	2	10.110. . . .	Connected	Primary:RPN00 (-cod8m)	Locked	LAN:ID:0	SRV-6-M900
<input checked="" type="checkbox"/>	4	04	450.13	000413B60053		10.110. . . .	This Unit	Primary:RPN00 (-cod8m)	Locked	LAN:ID:0	Printer-7-M900
<input checked="" type="checkbox"/>	5	05	0	000413B	4	0.0.0.0	Connection lost!	(any) RPN		DECT:RPN:any	

[Check All](#) / [Uncheck All](#)

With selected: [Remove from chain](#)

**DECT Chain**

Primary: RPN00: Kitchen-6-M900

└ Level 1: RPN01: Printer-6-M900

└ Level 1: RPN03: SRV-6-M900

└ Level 1: RPN04: Printer-7-M900

Warning: RPN01  
Warning: RPN03

Fig. 2

Setting	Description
<b>Settings for this unit (Fig. 1)</b>	
Multicell system	Select "Enabled" or "Disabled" from the drop-down list. <b>Default:</b> Disabled.
System chain ID	All base stations in a multicell system must have the same system chain ID. <ul style="list-style-type: none"> <li><b>Note 1:</b> The chain ID is used as a SIP account, i.e., extension 512, to identify different DECT chains in the same network. This means that you cannot assign extension 512 to handsets or use it for calls. It is possible to assign a different chain ID, but <b>by provisioning only</b> (valid input: up to 5 digits).</li> <li><b>Note 2:</b> There can be several multi-cell systems in the network. Up to 24 levels of base station chains are permitted.</li> </ul> <b>Default:</b> 512
Synchronization time (s)	Specifies the period in seconds when base stations in a multicell system synchronize with each other. If no keepalive packets are received within this period, the base station will be treated as unreachable in the multicell system. <b>Default:</b> 60 seconds
Data Sync	Select multicast or peer-to-peer from the drop-down menu. Multicast uses UDP. The multicast port (range 49200-49999) and IP address (range 224.1.0.0-225.1.0.0) are calculated from the chain ID. <b>Default:</b> Multicast
Primary data sync IP	IP address of base station data sync source, i.e., the base station handling the data synchronization. <ul style="list-style-type: none"> <li>When the data sync setting is multicast, this setting is disabled; the IP is selected automatically.</li> <li>If data sync setting is peer-to-peer, the source <b>must</b> be defined. The <b>default</b> value is 0.0.0.0.</li> </ul>

Setting	Description
Multicell debug	<p>224.1.0.0-225.1.0.0)</p> <ul style="list-style-type: none"> <li>• <b>None:</b> Debug disabled.</li> <li>• <b>Data sync:</b> Writes header information for all packets received and sent, to be used to debug any special issues. Note: This option should only be enabled for short periods of time when debugging is needed, as it generates a lot of syslog signaling.</li> <li>• <b>Auto tree:</b> Writes states and data related to the auto tree configuration.</li> <li>• <b>Both:</b> "Data sync" and "auto tree" are both enabled. Note: This option must only be used for debugging and not enabled on a normal running system.</li> </ul> <p><b>Default:</b> None</p>
<b>DECT system settings</b> (Fig. 1)	
RFPI system	The RFPI of the base station is entered automatically.
Auto configure DECT sync source tree	<p>Allows the multicell system to automatically synchronize the multicell chain/tree. This setting must be enabled to allow a secondary base station to take over the primary base station function if the original base station becomes disabled.</p> <p><b>Default:</b> Enabled</p>
Allow multi primary	<p>This feature allows two or more primaries in the same system and is used for multilocation setups. The primaries are unsynchronized, and handover is not possible. The setting <b>Auto configure DECT sync source tree</b> must be enabled.</p> <p><b>Default:</b> Disabled</p>
Auto create multi primary	<p>Available when the setting <b>Allow multi primary</b> is enabled. This setting enables the multicell system to generate a second cell when a base station goes off-line and radio connection between parts of the system is lost. After reconnecting the faulty base station, the system must be rebooted.</p> <p><b>Default:</b> Disabled</p>
<b>Base station settings</b> (Fig. 1)	
Number of SIP accounts before distribution load	<p>The maximum number of handsets that are permitted to perform location registration on a specific base station before the load is distributed to other base stations. The parameter can be used to optimize handset distribution among visible base stations.</p> <p>Note: In a multi-cell setup, a maximum of 8 simultaneous calls can be routed through each base station.</p> <p>Permitted <b>input:</b> Positive integers (e.g., 8)</p>
SIP server support for multiple registrations per account	<p>Select option from drop-down menu.</p> <p><b>Disabled:</b> (For servers that do not support moving SIP registrations from base station to base station when handset roams.) The SIP registration of a handset remains on the original base station when the handset roams to another base station. The handset does not SIP-register on the second base station.</p> <p><b>Enabled:</b> When a handset roams to another base station, the SIP registration of the handset on the original base station is deregistered, and the handset SIP-registers on the second base station.</p> <p><b>Default:</b> Disabled</p>

Setting	Description
System combination (number of base stations/repeaters per base station)	<p>Three settings are available.</p> <p>Note: The configuration must be set at the time the multicell system is configured. It cannot be modified:</p> <p><b>50/3:</b> 50 base stations and 3 repeaters  <b>127/1:</b> 127 base stations and 1 repeater  <b>254/0:</b> 254 base stations and 0 repeater</p>
<b>Base Station Group</b> (Fig. 2)	
ID	<p>Base station identity in the chained network. Automatically assigned consecutively when new base stations are added to the chain. With checkbox for selection for removal from chain.</p> <p><b>Permitted output:</b> Positive integers.</p>
RPN	<p>The Radio Fixed Part Number is an 8-bit DECT cell identity allocated by the installer. The allocated RPN within the SME must be geographically unique.</p> <p><b>Permitted output:</b> 0 to 255 (DEC) or 0x00 to 0xFF (HEX)</p>
Version	<p>Current firmware version on base station.</p> <p><b>Permitted output:</b> Positive integers with dot (e.g, 355.21).</p>
MAC address	<p>The media access control (MAC) address is a unique identifier assigned by the manufacturer. Printed on device's label and on <b>Home</b> page of web interface.</p>
IP address	<p>The Internet Protocol address assigned by the network the base station is located in.</p>
IP status	<p>Current base station status in the SME network.</p> <p><b>This unit:</b> Indicates that you are looking at this base station's web interface.</p> <p><b>Connected:</b> The base station is online in the network.</p> <p><b>Connection lost:</b> The connection to the base station has been lost.</p>
DECT sync source	<p>The drop-down menu contains the RPNs of each of the currently connected base stations followed (in parentheses) by the strength of the respective radio signal (RSSI) in dBm, as received by the base station whose web interface you are currently accessing. The maximum number of multicell chain levels is 24.</p> <ul style="list-style-type: none"> <li>When the DECT system setting <b>Auto configure DECT sync source tree</b> is set to "enabled", the sync source tree will be generated automatically.</li> <li>When the setting is "disabled", the sync source tree must be configured manually by selecting each base station's sync source from the drop-down menu.</li> </ul> <p>The visible option shows which sync source each of the base stations in the DECT chain is currently using. If you select a different option, the chain must be rebooted. Options:</p> <p><b>Select as primary:</b> This option is visible when the base station is selected as the primary. Select from the drop-down menu of a secondary base station to make that base station the primary.</p> <p><b>Primary:RPNxx (-xxdBm):</b> This option is visible when the base station is a secondary level base station whose sync source is the primary.  Example: Primary:RPN00 (-72dBm)</p> <p><b>Levelx:RPNxx (-xxdBm):</b> This option is visible when the base station is a secondary level base station whose sync source is another secondary level base station.  Example: Level1:RPN04 (-68dBm)</p> <p><b>(any) RPN:</b> Indicates a base station that is not synchronized to any other base station.</p>

Setting	Description
DECT property	<p>Base station characteristics in connection to the current multi cell network.</p> <p><b>Possible output(s):</b></p> <ul style="list-style-type: none"> <li>• <b>Primary:</b> Primary base station all other nodes in the chain synchronize to.</li> <li>• <b>Locked:</b> The base station is currently synchronized and locked to the primary.</li> <li>• <b>Searching:</b> The base station is in the process of locating to a DECT sync source.</li> <li>• <b>Free Running:</b> A locked base station that suddenly lost synchronization to the primary.</li> <li>• <b>Cell empty:</b> No current connection information from base station.</li> <li>• <b>Assisted lock:</b> Base station has lost DECT sync source, and Ethernet is used for synchronization.</li> <li>• <b>Sync. Lost:</b> Handset has an active DECT connection with the base station but the base station has lost connection to DECT sync source. The base station will continue to work as long as the call is active, then go into search mode when the call is terminated.</li> </ul>
Base station name	The name that was assigned to the base station in the settings on the <b>Management</b> page and that also appears at the top of its web interface, within the base station group, and in the DECT chain of a multicell installation.
DECT Chain	
Primary or Level 1 - 12	The DECT chain (also called DECT tree) is the graphic depiction of the levels and connections of the synchronized base stations and repeaters listed in the "Base Station Group" table.
Button <b>Reboot chain</b>	The reboot will start when there are no calls in the system.
Button <b>Force reboot chain</b>	The reboot will start immediately, and ongoing calls will be dropped.
Button <b>Reconfigure DECT tree</b>	DECT chain will be reconfigured

## Repeaters

For information on registering repeaters, see "Registering M5 repeaters" on page 27.

Setting	Description
Idx	Index of repeaters. Repeaters are numbered consecutively by the base station. With checkbox for registering them at and deregistering or deleting them from the base station.
RPN	<ul style="list-style-type: none"> <li>Assigned by base station during automatic registration.</li> <li>Selected from drop-down menu during manual registration of daisy-chained repeaters.</li> </ul>
Name/IPEI	The name given to the repeater during the registration process and its IPEI or only its IPEI, if no name assigned.
DECT sync source	Assigned by base station during automatic registration. Selected from drop-down menu during manual registration of daisy-chained repeaters.
DECT sync mode	The sync mode selected for the repeater during the registration process. Options: <b>Local automatical:</b> Recommended when registering repeaters directly at the base station or - in a multicell system - directly at the primary or any secondary base station in the chain. <b>Manual:</b> Obligatory when daisy-chaining repeaters to other repeaters.
State	<b>Enabled:</b> Repeater has been registered on the base station. <b>Present@RPNxx:</b> Repeater with DEC source RPNxx (base station or other repeater) is connected to the base station.
FW info	The firmware version on the repeater
FWU progress	Progress states: <b>Off:</b> No update in progress. <b>Initializing:</b> Update has been initiated. <b>X%:</b> Update in progress, X% completed. <b>VerifyingX%:</b> FWU writing is done, verification X% completed. <b>"Conn. term. wait" (Repeater):</b> Firmware has been updated; repeater will restart when there are no active calls in system. <b>Complete HS/repeater:</b> Update complete. <b>Error:</b> Unable to update (file not found, file not valid, etc.)



## Alarm

For information on configuring alarm settings and selecting them for individual handsets, see "Emergency alarm" on page 31. The M25 does not support emergency alarms.

This menu contains the available emergency alarm profiles that can be set for handsets registered at the base station. Configured profiles are selected for individual handsets on the **Handset** page. For more information, see "Selecting emergency alarm setting" on page 26 .

Setting	Description
Idx	Alarm profiles are numbered consecutively by the base station.
Profile alias	Optional: You can assign a name to each configured profile. The name is added in parentheses to the available profiles on the handset page.
Alarm type	Select <b>Alarm Button</b> from the drop-down menu to enable the alarm feature. <b>Default:</b> Disabled.
Alarm signal	The <b>Call</b> setting is <b>mandatory</b> . When the alarm button on the handset is pressed, the handset will call the phone number specified in the handset's Alarm settings. <b>Mandatory default:</b> Call.
<b>Note:</b> Changes to the following settings do not affect the M65 which always uses their default settings.	
Stop alarm from handset	Establishes whether or not an alarm can be cancelled from the handset. <b>Default:</b> Enabled.
Trigger delay	The number of seconds from the moment the handset's alarm button is pressed until the handset calls the alarm number or, if a pre-alarm delay is also configured, before the pre-alarm delay is triggered. <b>Default:</b> 0.
Stop pre-alarm from handset	Establishes whether or not a pre-alarm can be cancelled from the handset. <b>Default::</b> Enabled.
Pre-alarm delay	The number of seconds from the moment the handset's alarm button is pressed until the handset calls the alarm number. The display will show the "Pre-alarm triggered" message, and the emergency ringer, if set, will be played. <b>Default:</b> 0.
Howling	Establishes whether or not the handset will emit a howl while it is dialing the emergency number. ( <b>Howling not available on M65</b> ) <b>Default:</b> Enabled.

# Statistics

The **Statistics** page has four subpages: **System**, **Calls**, **Repeater**, and **DECT**. The visible default page is System, as indicated by the larger font (Fig. 1 and 2). Click one of the other links to bring that page onscreen (Fig. 3–5). Click the **Export** button top all statistical data to a comma-separated file (.csv); click on **Clear** to clear all statistical data.

**Note:** When the base station is running in a multicell setup, the two **leee1588** columns are added to the **System** table (Fig. 2).

## Statistics

### System / Calls / Repeater / DECT

Base Station Name	Operation/Duration D-H:M:S	DECT Operation D-H:M:S	Busy	Busy Duration D-H:M:S	SIP Failed	Handset Removed	Searching	Free Running	Source Changed
Sum	0-04:36:55/ 176-05:00:31	0-04:36:24	0	0-00:00:00	0	0	10	0	0

Fig. 1 - base station in single cell setup

### System / Calls / Repeater / DECT

Base Station Name	Operation/Duration D-H:M:S	DECT Operation D-H:M:S	Busy	Busy Duration D-H:M:S	SIP Failed	Handset Removed	Searching	Free Running	Source Changed	Ieee1588 sync lost	Ieee1588 primary lost
10.110.30.105 Kitchen-6-M900	0-04:56:30/ 0-04:59:42	0-04:55:24	0	0-00:00:00	0	0	1	0	0	0	0

Fig. 2 - base station in multicell setup

### System / Calls / Repeater / DECT

Base Station Name	Operation/Duration D-H:M:S	Count	Dropped	No Response	Duration D-H:M:S	Active	Max Active	Codec G711U: G711A: G722: G726:	Handover Attempt Success	Handover Attempt aborted	Audio Not Detected
Sum	0-04:38:27/ 176-05:02:03	28	0	0	0-00:03:45	0	2	35:0:7:0	0	0	12

Fig. 3

### System / Calls / Repeater / DECT

Idx/Name	Operation D-H:M:S	Busy	Busy Duration D-H:M:S	Max Active	Searching	Recovery	Source Changed	Wide Band	Narrow Band
1/ M5_6.18	0-00:00:00	0	0-00:00:00	0	0	0	0	0	0
Sum	0-00:00:00	0	0-00:00:00	0	0	0	0	0	0

Fig. 4

### System / Anrufe / Repeater / DECT

	Slot0	Slot1	Slot2	Slot3	Slot4	Slot5	Slot6	Slot7	Slot8	Slot9	Slot10	Slot11
Frequency0	4	11	7	5	6	6	5	5	5	4	2	7
Frequency1	4	6	5	5	6	6	14	4	3	7	6	4
Frequency2	5	9	4	2	4	7	5	8	5	7	7	3

Fig. 5

Setting	Description
<b>System</b> (Fig. 1 and 2)	
Base station name	In multicell setup: IP address and - if set - name assigned to base station in <b>Management</b> settings

Setting	Description
Operation/duration D-H:M:S	<b>Operation:</b> Time since last reboot ((days–hours:minutes:seconds) <b>Duration:</b> Time since last reset of statistics or firmware upgrade
DECT operation D-H:M:S	How long the base station has been running (days–hours:minutes:seconds)
Busy	The number of times the base station has been busy
Busy duration	The total time the base station has been busy for speech (8 or more calls active)
SIP failed	The number of times SIP registrations have failed
Handset removed	The number of times handsets have been marked as removed
Searching	The number of times the base station has searched for its sync source
Free Running	The number of times the base station has been free-running
DECT source changed	The number of times the base station has changed its sync source
<b>Calls (Fig. 3)</b>	
Base station name	In multicell setup: IP address and - if set - name assigned to base station in <b>Management</b> settings
Operation duration	<b>Operation:</b> Time since last reboot <b>Duration:</b> Time since data was last cleared or since last firmware upgrade
Count	Number of calls on base station
Dropped	Number of active calls that were dropped for reasons like handset moving out of range etc. An entry is stored in the syslog.
No response	Number of active calls that weren't answered, for example because handset was out of range etc. An entry is stored in the syslog.
Duration	The total time that calls were active on the base station.
Active	The total number of active calls on the base station (DECT and non-DECT calls). There can be up to 8 calls on a base station in a multicell installation, and up to 10 active calls on a single-cell base station.
Max active	The maximum number of calls that have been active at the same time.
Codec	Logging and count of codecs used on each call.
Handover success	The number of successful handovers
Handover failed	The number of failed handovers
Audio not detected	Number of incidents
<b>Repeater (Fig. 4)</b>	
Idx/name	Idx and - if set - name assigned to repeater in <b>Repeaters</b> settings
Operation	Total operation time since last reboot or reset.
Busy	The number of times the repeater was busy.
Busy duration	The total time that the repeater was been busy for speech (5 or more calls active).
Max active	The maximum number of calls that have been active at the same time.
Searching	The number of times the repeater has searched for its sync source.
Recovery	When the repeater has lost its sync source, it will attempt to lock onto another base station or repeater. Statistics show recovery mode.
DECT source changed	The number of times the repeater has changed its sync source.
Wideband	The number of wideband calls on repeaters
Narrowband	The number of narrowband calls on repeaters
<b>DECT (Fig. 5)</b>	
Slot 0 - 11	12 time slots for transmitting audio
Frequency 0 - 9	

## Call quality page

This page is normally not visible on the web user interface. It is accessed by adding CallQuality.jhtml behind the slash following the IP address of the base station in the address bar of your browser, e.g., **http://10.110.20.108/CallQuality.html**.

### Statistics

[System](#) / [Calls](#) / [Repeater](#) / [DECT](#)

Base Station Name	Type	Call count	Local/remote side	Jitter [ms]	Round trip latency [ms]	Packet loss [%]	R-value	MOS-value
10.110.25.101	Call	2	Local	Min: 8799.000	Min: 0.000	Min: 0.0	Min: 0.00	Min: 1.00
				Max: 8836.500	Max: 0.000	Max: 0.0	Max: 0.00	Max: 1.00
			Avg: 8817.750	Avg: 0.000	Avg: 0.0	Avg: 0.00	Avg: 1.00	
			Min: 8924.000	Min: 0.000	Min: 0.0	Min: 0.00	Min: 1.00	
	Relay conn	0	Remote	Max: 10178.125	Max: 0.000	Max: 0.0	Max: 0.00	Max: 1.00
				Avg: 9551.000	Avg: 0.000	Avg: 0.0	Avg: 0.00	Avg: 1.00
	Local	0	Local	Min: 0.000	Min: 0.000	Min: 0.0	Min: 0.00	Min: 0.00
				Max: 0.000	Max: 0.000	Max: 0.0	Max: 0.00	Max: 0.00
	Avg: 0.000		Avg: 0.000	Avg: 0.0	Avg: 0.00	Avg: 0.00		
	Min: 0.000		Min: 0.000	Min: 0.0	Min: 0.00	Min: 0.00		
Remote	Remote	Max: 0.000	Max: 0.000	Max: 0.0	Max: 0.00	Max: 0.00		
		Avg: 0.000	Avg: 0.000	Avg: 0.0	Avg: 0.00	Avg: 0.00		

Setting	Description		
<b>Call Quality</b>			
<b>NOTE:</b>			
Base station name	IP address and - if set - name assigned to base station in <b>Management</b> settings.		
Type	Type of connection (call and relay connection)		
Call count	The number of calls and relay connections		
Local/remote side	Divides both calls and relay connections into local and remote ones for further analysis.		
Jitter [ms]	Measures how the RTP packets are received. Lower values are better.		
Round trip latency [ms]	Measures the time it takes for RTP packets to reach their destination.		
Packet loss [%]	Percentages of packets lost.		
R-value	Measuring call quality from 0–120.		
	<b>User satisfaction level</b>	<b>MOS</b>	<b>R-Factor</b>
	Maximum using G.711	4.4	93
	Very satisfied	4,3–5.0	90–100
	Satisfied	4.0–4.3	80–90
	Some users satisfied	3.6–4.0	70–80
	Many users dissatisfied	3.1–3.6	60–70
	Nearly all users dissatisfied	2.6–3.1	50–70
Not recommended	1.0–2.6	Less than 50	
MOS value	Measures subjective call quality for a call. Scores range from 1 for "unacceptable" to 5 for "excellent. VoIP calls often are in the 3.5 to 4.2 range. See table at <b>R-value</b> , above.		

## Configuration

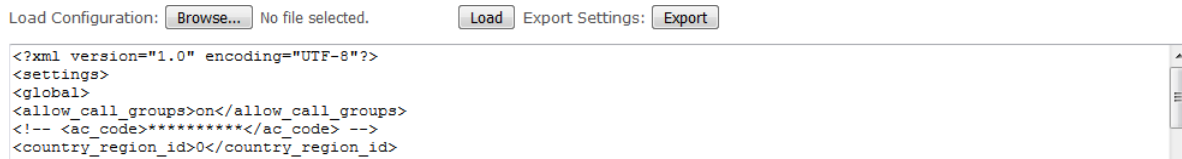

This page shows the current settings of the base station; they can be copied into a file, but not edited. To load a new configuration, click on **Browse** and select the file, then click on **Load**. To export the settings, click on **Export**.

For information on how to provision the configuration, see the "Provisioning Guide M900\_M700\_M300" at <https://service.snom.com>. Select **DECT**, then **M900**.

## Syslog

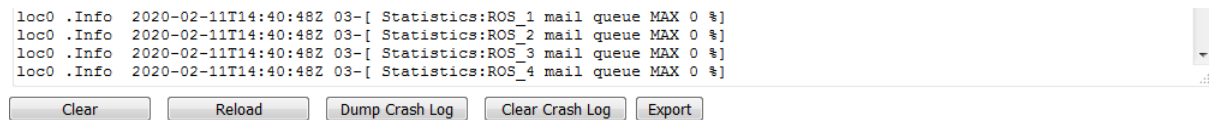

This page shows the live feed of system level messages of the current base station. The messages shown here depend on the syslog settings configured on the **Management** page. To dump the log, use the copy-and-paste function of your PC operating system to transfer the contents to a data file. If you are using Windows, press Ctrl+s, select a file location and a file type in the pop-up window, name the file, and click on **Save**.

## SIP Log

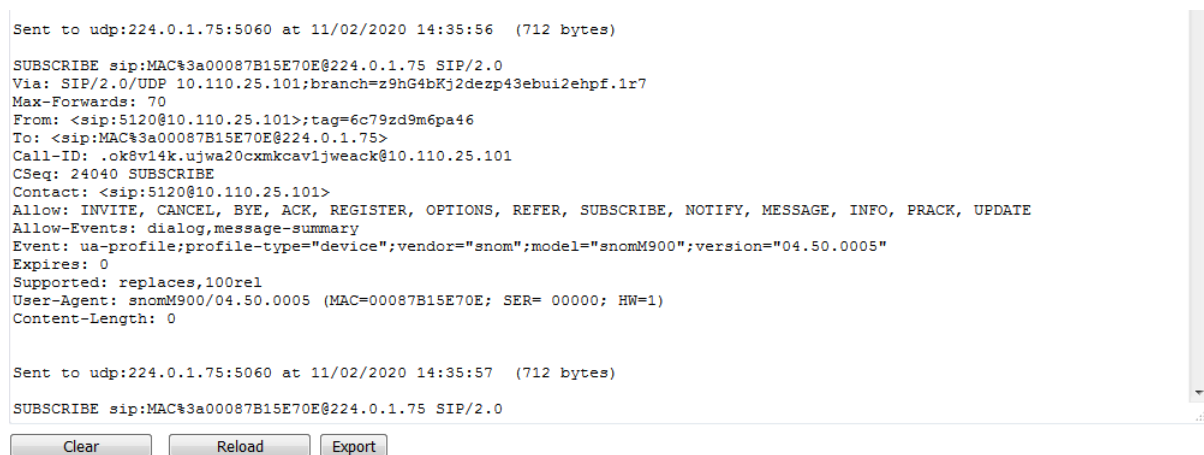

This page shows server-related messages that are logged during the operation of the SME system. To dump the log, use the copy-and-paste function of your PC operating system to transfer the contents to a data file. If you are using Windows, press Ctrl+S, select a file location and type in the pop-up window, name the file, and click on **Save**.

## Appendix 1 - Installing the M900 Outdoor

The M900 Outdoor version is delivered pre-installed in a protective casing suitable for outdoor installation. Follow these instructions for connecting the unit to your PoE network and mounting it on a wall or pillar.

1. Unscrew the four screws and remove the lid of the M900 housing.

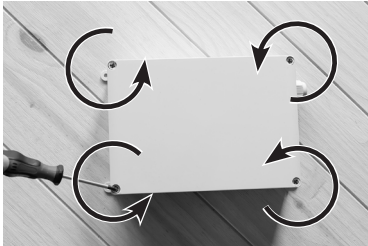

2. Remove the packing foam.

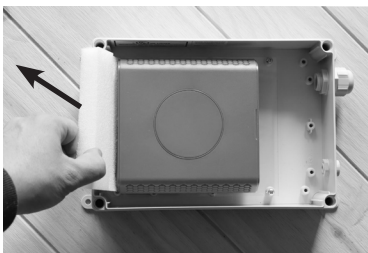

3. Slide the M900 down off its mounting plate (to the right in Fig. 3) and put it next to the housing.

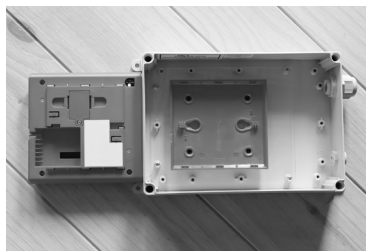
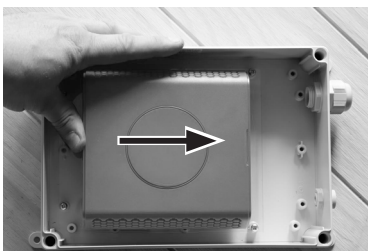

4. Unscrew the cap counterclockwise and push the foam rubber ring out of the cable bushing with a screwdriver.

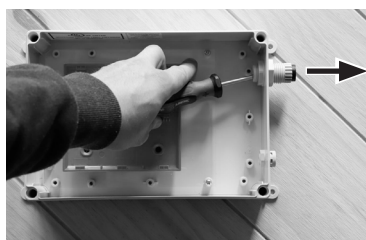
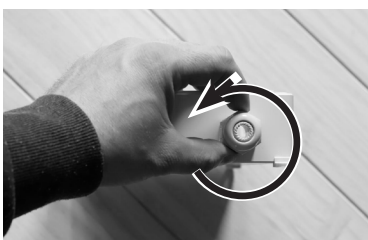

5. Push the PoE cable (not included in delivery) through the cap and put the foam rubber ring on the cable between cap and RJ45 plug.



6. Push the PoE cable through the cable bushing and plug it into the connector of the M900.

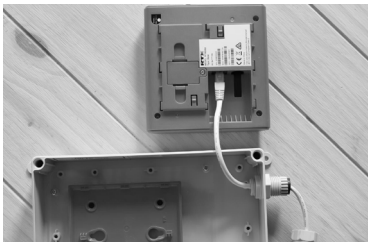

7. Place the M900 on its mounting plate and push it upwards until it clicks into place.

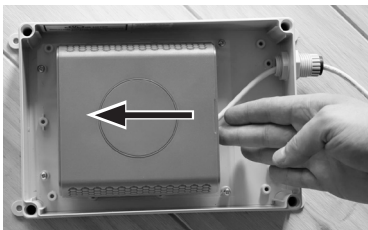

8. Turn the cap on the cable bushing clockwise to tighten it.





9. Screw the lid onto the housing.

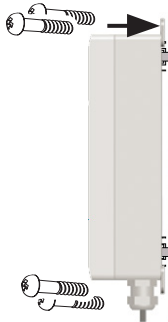

10. For optimal radio coverage mount the base station as high as possible on a wall or pillar (screws/wall anchors are not included in the delivery).
  - Do not mount the base station upside down which would significantly reduce radio coverage.
  - To prevent overheating, do not place the base station in a location where it is exposed to sunlight.



11. To look up the IP address of the base station, press the  key on an M-series handset to open the Settings menu. On the M25 handset, press the OK-key . (Handsets are not included in the delivery.)
12. Type \*47\*.
13. Open the browser of a PC in the same network as the base station, and type the IP address into the address bar to open the base station's web user interface. Default user name and password: admin.
14. Continue as described in this manual, starting at "Configuring" on page 19.